

Connecting Systems

for interior and exterior finishing, window construction,
and wood structures



Connecting Your Ideas ...

KNAPP®
connectors.com

Patented by
KNAPP®

**Innovative
solutions
Made in Austria
Family Business
since 1983
Your business
partner for
interior and
exterior design
window
construction
wood structures**



For 40 years, our teams have been committed to working with our clients to offer cutting-edge and innovative assembly solutions. Drawing inspiration from the expectations and developments in the wood industry, our family business has made it its mission to develop high-quality products for creating invisible, self-tightening, and detachable joints for wood and wood materials.

Our story began with the development of a two-part connector named Champ, which has proven its worth millions of times to this day. Shortly thereafter, Friedrich Knapp invented the lamelloid solutions with self-clamping sharp edges, Fast, Silver, and Sunny. This avant-garde technology has since inspired many.

In this new catalog, you will find these still-relevant solutions, as well as our new generation of connectors for furniture bodies in lamelloid form, the FIYU family, along with several other product innovations.

This documentation now brings together all of our assembly and fixing systems for interior fittings and joinery, as well as our range of products for exterior joinery, including, among others, the FIXclip product family for invisible fixing and sealing of glazing beads, and the RICON® product family for post-and-beam structural assemblies for curtain walls. This latest range of small timber connectors allows for the creation of joints in wood sections from 20 mm thickness, with a capacity for glazing loads up to 1100 kg. The RICON® series is also available in an all-stainless version for the construction of uncovered outdoor wood structures, ideal for pergolas, for example, and is also adaptable for hybrid joints between wood, concrete, and steel.





Let yourself be inspired and find new ideas for your projects. We wish you many creative ideas with Knapp's assembly solutions!

The Knapp family



Table of Contents



KNAPP slide-in connectors, for furniture, interior design, and millwork

	SUNNY	8
	Plastic biscuit connector with integrated locking tab, for RTA furniture, case goods, architectural millwork, gluing aid, without using clamps	
	SILVER	8
	Aluminum die-cast biscuit connector with integrated locking tabs, for RTA furniture, case goods, miter joints, without using clamps	
	CHAMP	9
	PA6 fiber-glass reinforced plastic biscuit connector, for furniture, case goods, and architectural millwork, without using clamps	
	METAL	9
	Universal biscuit connector made of zinc die-casting, for pre-fabricated products, furniture, without using clamps	
	CHICO	10
	Aluminium die-cast slide-in connector, for furniture, interior design, hardwood cladding panels	



KNAPP clip-in, knock-in and joint connectors, for furniture, interior design, and millwork

	FAST	10
	Plastic clip-in connector, for (RTA) panels, claddings, casings, and moldings	
	FIYU® FAST and FIYU® LOCK	11
	Tongue and groove plastic plug-in connector, for cabinet units, fixed shelves, mitre-cut junctions and intermediate uprights, or for fixing trim, removable covers and surface-mounted moulding	
	CLIPS	13
	Plastic clip-in connector, for panels, covers, and wainscoting	







KNAPP clamp connector for indoor and outdoor use

	DEKCLICK®	14
	Clamp connector, available in 3 versions, for interior and exterior use, acoustic ceilings, wall panels, as well as furniture and interior design	





KNAPP connectors and fasteners for stairs and table legs, KNAPP® adhesives

	easy-con®	17
	Tension element for table legs and stair treads	
	TREPPO	18
	Levelling screw for stair treads	
	KNAPP® adhesives	19
	D4 Polyurethane adhesives - heat and water-resistant up to 120 °C (248 °F)	





KNAPP hanging systems for interior designs and furniture

	KOMBI	13
	Hook-in biscuit connector of alloy die-cast, for interior design, trade fair, shop fitting, wood veneers, facade paneling and cladding, and decorative wall panels	
	DUO 30 mL/30 oL	20
	Hook connector, in galvanised steel, for wall cladding, fixing decorative pieces, assembling handrails, etc.	
	DUO 35 mL/35 oL	20
	Hook connector, in galvanised steel, for wall cladding, fixing decorative pieces, assembling handrails, etc.	
	DUO 30 inox A5	21
	A5 stainless steel hanging system, for wall cladding and fixing decorative pieces for boats, yachts, seaside or outdoor installations	
	UNO 30	22
	A2 stainless steel hanging system for staircases, wall cladding, fixing decorative pieces, either directly or on a wall mount	
	Locking clip	22
	For DUO 30, DUO 30 inox and UNO 30	

KNAPP wooden nails and dowels for interior designs and furniture

	TUCK	23
	Metal spring dowels for the assembly of furniture, cabinets elements, aiding in glue bonding	
	Miller® Dowel	23
	Wooden nails, for assembling designer and eco-friendly furniture	
	KNAPP®-Dowel	24
	Plastic dowels, for assembling furniture cabinet, windows, doors, outdoor furniture, humidity-resistant	
	QUICK-SET	25
	2-parts dowel – connector, for assembling furniture cabinet components, without glue or visible screws	

KNAPP dovetail snap-in connectors

	KLICK	26
	Double dovetail connector, in plastic, for concealed fixing of mouldings, trims or covers	
	sKLICK	26
	Dovetail snap-in connector to screw in plastic, for concealed fixing of mouldings, trims or covers	
	KLICKpro	27
	Dovetail groove in plastic, crafted for use in combination with KLICK or sKLICK connectors	
	miniKLICK	27
	2-piece dovetail connector, in plastic, for concealed fixing of small decorative molding and glazing beads	

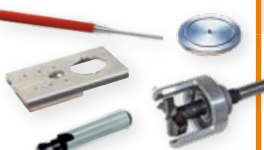

KNAPP tools and accessories

	Accessories for Knapp connectors' installation	28
	Accessories for installing Knapp connectors	













Machines suggestions

	Our machinery equipment partner	30
	Machining for the KNAPP® connectors industrial installation	



KNAPP cabinet body connectors

	CONTRA Zinc-plated steel connector for assembling cornices, moldings, and at a 90° miter	31
	MODULAR with shoulder screws Spring steel connectors for assembling body components on sides, bottoms, and shelves, especially suited for central bottoms/central walls with a double connection	32
	MODULAR Anti-Torsion Spring steel connectors for bodies and frames, with a stop for secure and twist-resistant body or frame connections	33



KNAPP connecting systems for worktops, frames and stairs

	Zipbolt™ 90 KD Joint connector for countertops, frames and solid furniture elements from 22 mm thick	34
	Zipbolt™ 85 Joint connector for panel joints from 22 mm thickness	34
	Zipbolt™ 120 Joint connector for panel joints from 22 mm thickness	35
	Zipbolt™ 170 Joint connector for panel joints from 22 mm thickness	35
	Zipbolt™ 100 Mini Joint connector for panel joints from 16 mm thickness	36
	Zipbolt™ 100 Mini UIPHa slim Joint connector for panel joints from 13 mm thickness	36
	Zipbolt™ Mini UT 30 KD Joint connector with metal housing, for thin panels	36
	Zipbolt™ Mini UT 43 KD Joint connector with metal housing, for mounting cabinet elements	37
	Zipbolt™ Slipfix Railbolt Connector for 90° handrails	37
	Zipbolt™ Exterior Slipfix Connector for exterior 90° handrails	37
	Zipbolt™ UT Post Anchor Connector for balustrade posts	38
	Zipbolt™ XT Post Anchor Connector for outdoors balustrade posts	38





KNAPP connectors for wooden frames, small wooden constructions, beds, saunas

	DUO-System Connecting systems in galvanised steel, for joining solid wood elements in furniture, staircases, booths	39
	Solid® Timber hanging systems, for metal-free bed rail framing	42





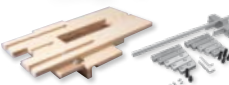
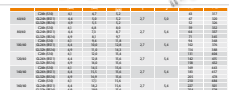

KNAPP connectors for building light structures and frames

	ACRO-System Zinc-plated steel connectors for assembling small beams or crosspieces and for stairs	44
	BASIS-System Fixing system for posts	46

KNAPP connecting systems for timber curtain walls

	RICON® inox	48
	Universal connectors for loads up to 17.2 kN, A2 stainless steel for use in service class 3 (outdoors)	
	RICON® inox DA (double) and EAR (with inserts)	53
	Connectors with connecting nuts and inserts for double joint applications	
	RICON®	54
	Zinc-plated steel connectors, for assembling wooden structures such as curtain walls, pergolas, verandas and frameworks	
	RICON® DA (double) and EAR (with inserts)	60
	Connectors with connecting nuts and inserts for double joint applications	
	Accessories RICON®	61
	Assembly aid for RICON® and RICON® inox	
	RICON® technical data	62
	Load capacity table for curtain walls, solutions for mixed wood types, concrete or steel constructions	

KNAPP solutions for glazing bead fixing for wood and wood-aluminium joinery

	FIXclip-Profile	69
	Composite profiles for fixing and sealing glazing and glazing beads in wood and wood-aluminium frames	
	FIXclip-Profile GLE17 and GLE17 Plus, for rebate depths from 16 mm upward	70
	FIXclip-Profile GLE18, for rebate depths from 20 mm upward	72
	FIXclip-Profile GLE20, GLE20 Plus and GLE20 N, for rebate depths from 24 mm upward	73
	FIXclip GLE20 Plus, single holder	75
	Clipping solution for invisible fixing of glazing and glazing beads in wood and wood-aluminium joinery	
	FIXclip H12, H16, H20, single-point fixing	76
	Clipping solution for invisible fixing of glazing and glazing beads in wood and wood-aluminium joinery	

KNAPP solutions for fastening deck boards and cladding

	QUATRO 65, Z-DECK	78
	Invisible fastening systems for decking, cladding and wall cladding panels, indoors or outdoors	

KNAPP Box sets and Mini Packs

	KNAPP® Box	82
	Connector sets with accessories and/or templates presented in ready-to-use boxes	
	KNAPP® Mini Packs	85
	Small-quantity assortments of connectors	

Symbols: these symbols can be found on every connectors' page in this brochure.

H Wood to wood connection

G Wood to glass connection

S Wood to steel connection

K Wood to plastic connection

B Wood to concrete connection

 Visible

 Concealed

 Enabling prefabrication in workshop

 Horizontal assembly

 Vertical assembly

 Assembly from all sides

 Flush installation

 Clamp-free

 Certifications

Biscuit slide-in connectors

Biscuit clip-in connectors

Knock-in connectors

Tension element for stair tread mounting and table legs

Levelling screw for stair treads

Polyurethane adhesives

Hook-in connectors

Dowels and timber pegs

Dovetail clip connectors

KNAPP® accessories

Connector for case goods

Cabinet connectors

Connectors for counter tops, stairs and frames

Frame connectors

Wood joiners

Furniture and fittings

SUNNY



Slide-in biscuit connectors with integrated locking tab, plastic

Art.-No. K053

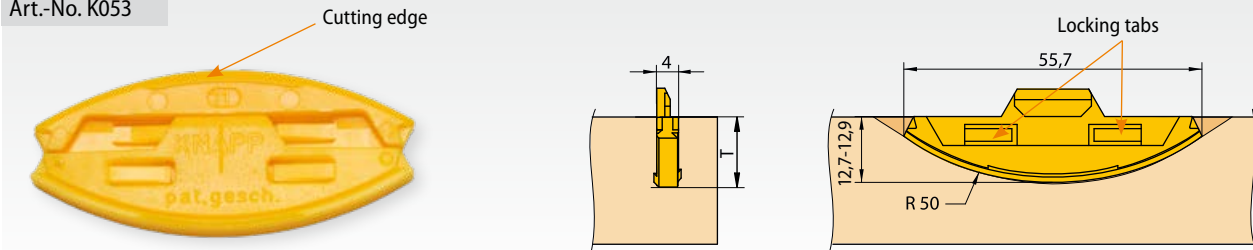

Applications:	Case goods, furniture, architectural millwork, shop fitting, clamping aid for miter joints and corners.
Advantages:	Concealed, self-tightening biscuit connector with integrated locking tabs.
Suitable materials:	All softwoods and board materials without laminate surfaces.
Installation:	Cut slot with biscuit joiner (#20) according to groove depth T. Knock-in both connector halves opposite of one another, following the radius of the biscuit cut using hammer and insertion tool.
Mounting:	Using the cutting edges on the side of the workpieces, which trace the base of the milling cut along the radius.
Accessorie:	Insert tool Art.-No. K049/E



Cut #20 biscuit slot



Insert, knock in



Knock-in with the insert tool



Assemble



SUNNY

SILVER



Slide-in biscuit connector with integrated locking tabs, alloy-diecast

Art.-No. K049

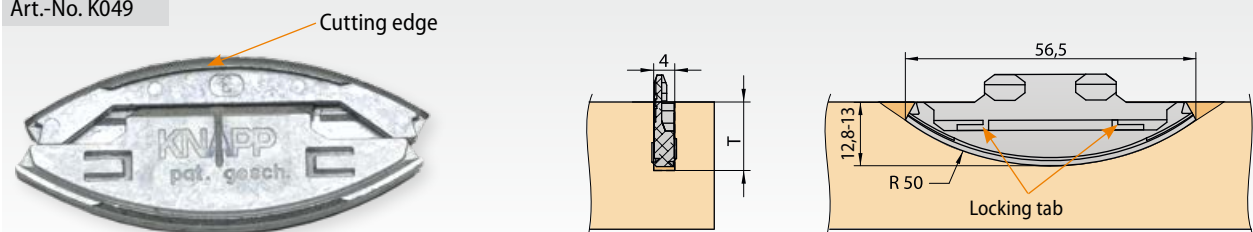

Applications:	Case goods, furniture, architectural millwork, shop fitting, clamping aid for miter joints and corners.
Advantages:	Concealed, self-tightening, demountable connector with integrated locking tabs.
Suitable materials:	All softwood board materials.
Installation:	Cut slot with biscuit joiner (#20) according to groove depth T. Knock into the biscuit slot with a hammer following the radius of the cut.
Mounting:	Using the cutting edges on the side of the workpieces, which trace the base of the milling cut along the radius.
Accessorie:	Insert tool Art.-No. K049/E



Cut #20 biscuit slot



Engage locking tabs (optional)



Insert, knock in



Knock-in with the insert tool



Assemble



SILVER

CHAMP



Slide-in biscuit connector, glass fiber reinforced plastic

Art.-No. K023

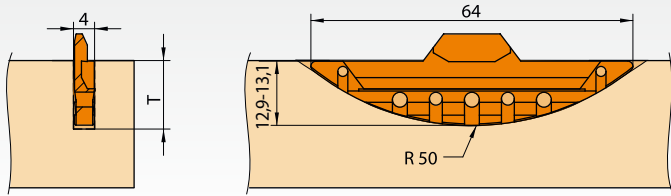

Tip: Moisten surface before gluing if wood is very dry.

Applications:	Case goods, furniture, architectural millwork, shop fitting, clamping aid for miter joints and corners.
Advantages:	Concealed, self-tightening, demountable.
Suitable materials:	All wood and board materials.
Installation:	Cut slot with biscuit joiner (#20) according to groove depth T. Apply KNAPP®-ADHESIVE PU+ into slot and insert connector halves.
Mounting:	By gluing with KNAPP®-ADHESIVE PU+.
Accessorie:	KNAPP®-ADHESIVE PU+ Art.-No. Z011



Cut #20 biscuit slot



Glue



Position with template



Assemble



CHAMP

METAL



Slide-in biscuit connector, alloy-diecast

Art.-No. K026

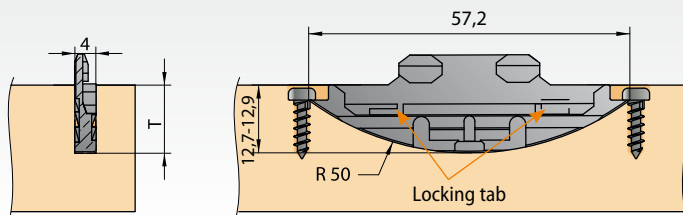

Applications:	Case goods, furniture, architectural millwork, shop fitting, door frames.
Advantages:	Concealed, self-tightening, demountable connector with optional integrated locking tabs.
Suitable materials:	All wood and board materials.
Installation:	Cut slot with biscuit joiner (#20) according to groove depth T. Insert both connector halves into the biscuit cuts and mount by means of PH-screws.
Mounting:	Screw in with PH-screws.
Accessories:	PH-screw 3x13 mm Art.-No. Z600, PH-screw 3x25 mm Art.-No. Z601



Cut #20 biscuit slot



Engage locking tabs (optional)



Screw in



Assemble



METAL

CHICO



Slide connector, alloy-diecast

Art.-No. K030

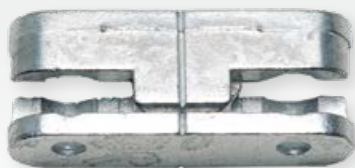

Art.-No. K030/OA

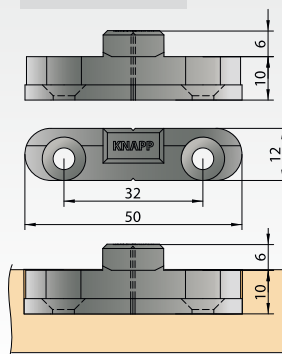

Art.-No. K030/MA

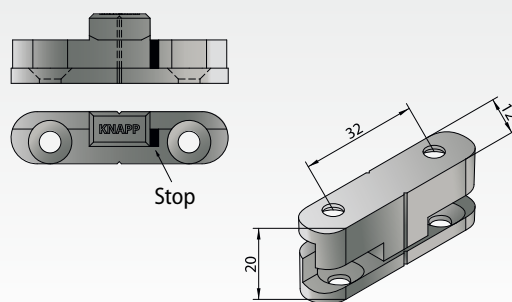

Applications:	Heavy furniture, case goods, panels.
Advantages:	Concealed, self tightening, demountable with integrated stop.
Suitable materials:	All wood and board materials.
Installation:	Cut mortise with plunge router or CNC machine.
Mounting:	Screw in with CS Ø 4,5 mm.



Cut #20 biscuit slot



Insert



Screw in a



Screw in b



Assemble



CHICO

FAST



Clip-in biscuit connector, plastic

Art.-No. K058

Cutting edge

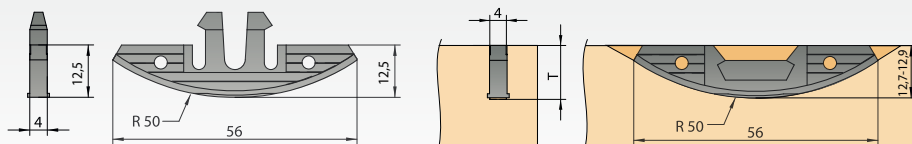

Applications:	Case goods, furniture, architectural millwork, face frames, door and window casing, clamping device for miter joints and corners.
Advantages:	Concealed, self-tightening, demountable connector, immediately load bearing.
Suitable materials:	All softwoods and board materials without laminated surfaces.
Installation:	Cut slot with biscuit joiner (#20) according to groove depth T. Knock-in both connector halves following the radius of the biscuit cut using hammer and insertion tool.
Mounting:	Using the cutting edges on the side of the workpieces, which trace the base of the milling cut along the radius - Optionally, glue prior to insertion with KNAPP®-ADHESIVE PU+ for a stronger hold.
Accessories:	Insert tool Art.-No. K049/E



Cut #20 biscuit slot



Insert, knock in



Knock-in with the insert tool



Assemble



FAST

FIYU®



Knock-and-plug cabinet in connector

FIYU® FAST

Art.-Nr. K855

+ Grub screw 6x12 mm (optional) | Art.-No. Z428

Benefits:

- | Plug-in connection on tongue and groove basis for immediate stability
- | Tight and precise guidance
- | Manual and industrial processing
- | Stackable
- | High clamping force and 100% perfect fit
- | Safety due to high load capacity
- | Loadable in two directions



- 1** FIYU® FAST – Spreading lamella
- 2** Fixing edge
- 3** Cutting edges
- 4** Guide pin
- 5** Spring hook

- 6** FIYU® FAST – Clamping lamella
- 7** Cutting edge
- 8** Spring hook receiver
- 9** Slots for guide pins
- 10** Grub screw 6x12 mm (optional)

FIYU® LOCK

Art.-No. K856

= FIYU® LOCK plug-in part | Art.-No. K856/S

+ Tensioning screw M5x13 mm | Art.-No. K857

Art.-No. K859

= FIYU® LOCK receiving element + plug-in part | Art.-No. K856/A + Art.-No. K856/S

+ Tensioning screw M5x13 mm | Art.-No. K857

Benefits:

- | For 16 mm material thickness and above
- | 2 in 1 system, push-fit or sliding connection
- | Retrofitting installation of shelves as shelf supports
- | Flexible assembly sequence
- | Quick and easy disassembly
- | Mechanically interlocked

- 1** FIYU® LOCK – plug-in part
- 2** Cutting edge
- 3** Spring lamella (3,6 mm)
- 4** Hole for optional fixation



- 5** Slot shaped recess for the spring lamella (4 mm)
- 6** FIYU® LOCK – receiving element
- 7** Tensioning screw M5x13 mm

Applications:	For cabinet units, fixed shelves, mitre-cut junctions and intermediate uprights, or for fixing trim, removable covers and surface-mounted mouldings.
Advantages:	Concealed, self-tightening, re-assemblable tongue and groove connector, immediately ready for use.
Suitable materials:	All softwood and uncoated plastic materials (FIYU® FAST) ; All woods, synthetic materials (FIYU® LOCK) .
Installation:	With CNC, flat dowel machine, adjust depth setting accurately.
Mounting:	insert plug-in part and holding part into milled groove, and clip the components together.
Accessories:	Grub screw FIYU® 6x12 mm (FIYU® FAST) Art.-No. Z428, Tensioning screw M5x13 mm (FIYU® LOCK) Art.-No. K857, Allen key with ball end Art.-No. K647

FIYU® – easy to connect, safe, fast and reversible

FIYU® - the connectors with cutting edges have clever details:

Thanks to well thought-out details, it not only connects securely and exceptionally quickly, it is also ideal for countless areas of application. It connects cabinet parts from an angle of 0° to 135°.

The FIYU® LOCK is a particularly suitable solution for retrofitting shelves. It even holds all by itself - saving time and money. Optionally, the connector can fix the components with a tensioning screw.

FIYU® FAST is a self-tensioning cabinet and connector that can connect miter joints and 90° joints firmly and detachably. It can also be used as a gluing aid.

Installation



Insert the connectors flush with the panel.



Assemble the components by fitting them together using hand pressure or a rubber hammer.



Groove dimensions

(Dimensions in mm)

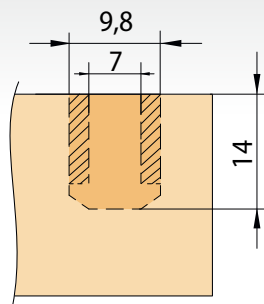

FIYU® FAST and FIYU® LOCK

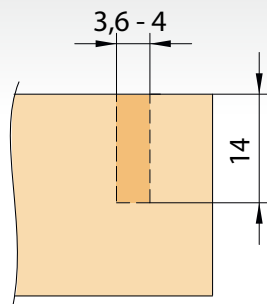

FIYU® LOCK

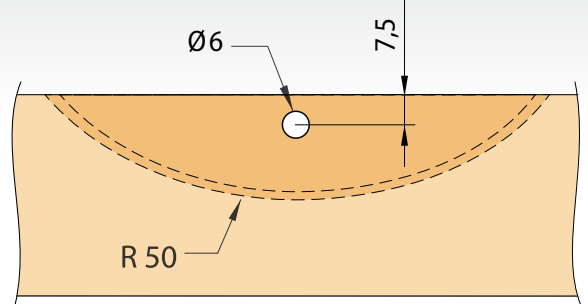

FIYU

CLIPS



Clip-in biscuit connector, plastic

Art.-No. K054

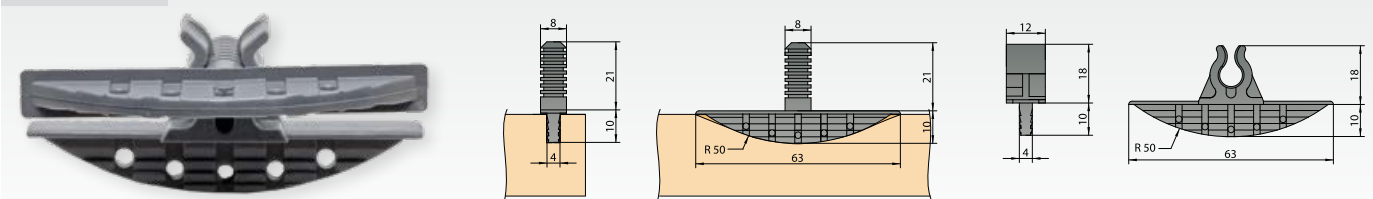

Tip: Moisten surface before gluing if wood is very dry.

Applications: Cabinets, case goods, removable panels, toe kicks, miter joints, shop fittings.

Advantages: Self-tightening, demountable connector, adjustable (with or without gap).

Suitable materials: All wood and board materials.

Installation: Cut slot with biscuit joiner (#20) according to groove depth T.10, apply KNAPP®-ADHESIVE PU+ into biscuit cut and insert connector halves.

Mounting: With KNAPP®-ADHESIVE PU+.

Accessories: KNAPP®-ADHESIVE PU+ | Art.-No. Z011



Cut #20 biscuit slot



Glue



Insert



Assemble



CLIPS

KOMBI



biscuit connector, alu/zinc diecast

Art.-No. K614

Art.-No. K615

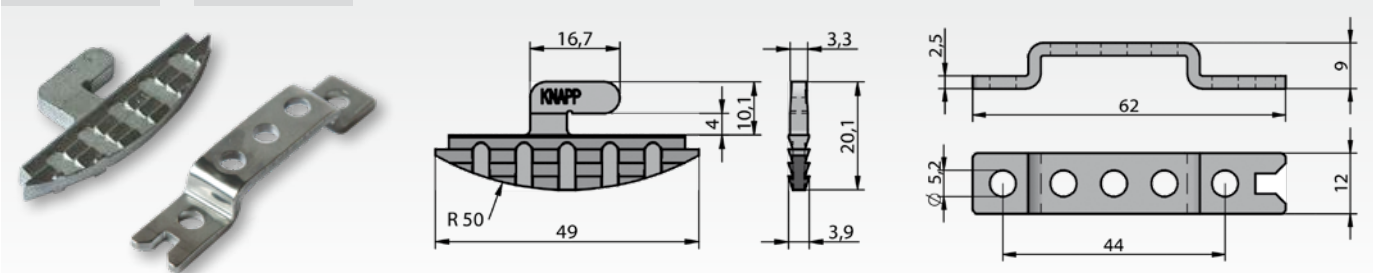

Applications: Architectural millwork, wall/facade paneling and cladding.

Advantages: Concealed, self-tightening biscuit connector.

Suitable materials: All wood and board materials.

Installation: Cut slot with biscuit joiner (#20) adjusting depth to 10 mm.

Mounting: install with PH-screws Ø 3x25 mm or glue with KNAPP-ADHESIVE PU+.

Accessories: PH-screw 3x13 mm | Art.-No. Z600, PH-screw 3x25 mm | Art.-No. Z601, CS stainless steel screw A2 4,5x35 mm | Art.-No. Z409, KNAPP® Adhesive PU+ | Art.-No. Z011



Positioning



Mount KOMBI bracket with screws



Simply hook in the components



Can be detached if needed



KOMBI

DEKCLICK®



Clamp connector

DEKCLICK® versions

Benefits:

- | Quick clipping on - can be mounted vertically and horizontally
- | Prefabrication and tool-free assembly
- | Flexible joints design
- | Stable - particularly high load-bearing capacity using KNAPP®-KLEBER PU+
- | Quick assembly - joint immediately loadable after it has been plugged together
- | Can be dismantled several times
- | To be screwed-on or glued

Art.-No. K010/Set black

= DEKCLICK® lamellar clamp | Art.-No. K011/S

+ DEKCLICK® block | Art.-No. K010/S

Removable version, black ($F_{max} = 8 \text{ kg}$)

Art.-No. K010/Set grey

= DEKCLICK® lamellar clamp | Art.-No. K011/G

+ DEKCLICK® block | Art.-No. K010/G

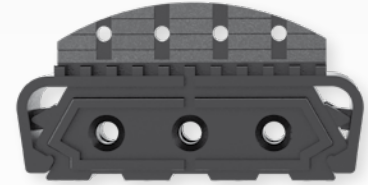
Extra grip version, grey ($F_{max} = 20 \text{ kg}$)

Art.-No. K012/Set black

= DEKCLICK® screw clamp | Art.-No. K012/S

+ Bloc DEKCLICK® | Art.-No. K010/S

Screw clamp version, black ($F_{max} = 8 \text{ kg}$)**1** DEKCLICK® clamp**2** Lamellar bar for gluing**3** Positioning lug**4** Stop pin for transverse fixation**5** Clamp hook with clip function**6** DEKCLICK® block**7** Block coupling profile**8** Fixing screw**9** Crosswise holes for screw connection**10** Stop and latching lugs

DEKCLICK

Applications: For interior and exterior use, acoustic ceilings, wall panels as well as furniture and interior fittings.

Advantages: 3 variants for controlled resistance and more possible uses.

Materials: POM -acetal plastic- (resilient) and polyamide (UV and weather resistant, recyclable).

Installation: Cordless screwdriver, flat dowel machine, CNC milling machine, various milling machines, profile milling cutter for block strip and decorative strip.

Mounting: Position, screw (e.g. SK stainless steel screw 5x50 mm), clip on, glue (KNAPP® adhesive PU+) and clip on.

Accessories: CS screw inox A2 5x50 mm | Art.-No. Z950, CS screw inox A2 4,5x35 mm | Art.-No. Z409, CS-screw 4x16 mm | Art.-No. Z422, EURO-screw 6,3x10 mm | Art.-No. Z510, Square nut M6 DIN 562 | Art.-No. Z896, Torx Bit T15 | Art.-No. Z411, Torx Bit T25 | Art.-No. Z412, Milling cutter DEKCLICK® | Art.-No. Z658, DEKCLICK® shank milling cutter for block rail | Art.-No. Z893, Cutting head for DEKCLICK® H 20/4 with Ø30 mm borehole | Art.-No. Z894, KNAPP®-ADHESIVE PU+ | Art.-No. Z011.

DEKCLICK® clamp connector

For indoor and outdoor use - 3 versions: screw clamp, removable, and extra grip

DEKCLICK® – Solution for elegant walls and ceilings



Acoustic ceilings

For invisible fastening, DEKCLICK® combines a block or a block rail milled from wood as a base with a clamp as a counterpart which is simply clipped on and locks securely in place in a two-steps process.



Decorative walls

DEKCLICK® block has both lateral and axial holes so that it meets a wide variety of screw connection requirements. With a centre screw connection in the axial direction, the connection is automatically aligned in the direction of alignment.



Wall cladding

The screw clamp version of DEKCLICK® is used for quick fastening. However, it offers additional processing possibilities. The clamps can be attached directly to the construction elements with EURO-screws, or in the 32 mm raster.



Acoustic ceiling, training room, Knapp GmbH (Austria) | Design in white glazed fir with DEKCLICK® clamp connector.

Installation on a wooden block rail - Final width ± 60 mm



As an alternative to the DEKCLICK® blocks, it is possible to fix the clamp to a wooden milled block rail (milling cutter available on request).

The milled block rail is screwed onto the load-bearing structure and placed in position. The clamps are easy and flexible to move along the length of

the block rail or are perfectly fixable if necessary. Assembly with block rails is ideal for large surfaces.

Pairing blocks, for easy assembly of several elements



Join the blocks and screw them together with Ø4 mm CS-screws.

DEKCLICK® shank milling cutter for block rail

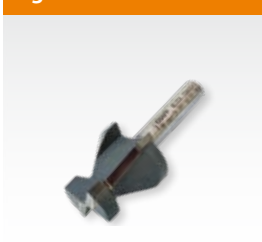

Milling cutter DEKCLICK®



Grooving cutter for DEKCLICK® H 20/4 with Ø30 mm borehole



Lamellar DEKLICK® installation with wooden block rail



1

Position the block strip and screw it in place.



2

Clip the clip onto the block strip.



3

Mill 4x12 mm grooves and fill KNAPP® Adhesive PU+ into the groove or apply to the slat bar.



4

Attach the slats to the clamp. Allow the adhesive to bond.

Lamellar DEKLICK® installation with wooden block



1

Position and fix the block onto the base with screw.



2

Clip the clamp onto the block.



3

Mill a 2-level groove and fill it with KNAPP® Adhesive PU+ or apply the adhesive on the block rail. Clip the workpiece onto the clamp.

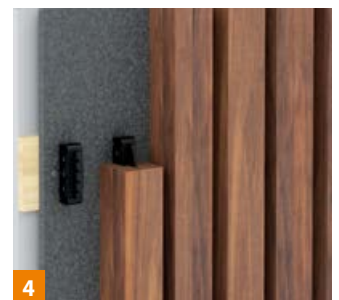

4

Clip the decorative wooden strips over the clamps and allow the glue to harden.

Safety advice:

If necessary, attach additional fasteners to ceilings or and elements. Observe the general building regulations in your application project.

Installing DEKLICK® screw clamp directly to the wall



1

Position DEKLICK® screw clamp using the screw holes.



2

For fixing to wood-concrete or screw directly to the wall.

Panel installation with clamp screw



1

Pre-drill a Ø 5 mm hole for the EURO-screw.



2

Screw down.

Installing the screw clamp with fixed or adjustable positioning



1

Fasten with Ø 4 mm CS-screws.



2

Adjust ± 2 mm.

Screw clamp installation with block and block strip



DEKLICK® block (extra grip) with screw clamp.



Block rail with lamellar clamp.

easy-con®



Tension element for table legs and stair treads



Art.-No. Z330

easy-con® M8-16-50

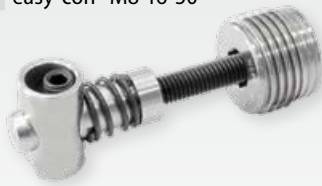

Art.-No. Z336

easy-con® M8-16-25

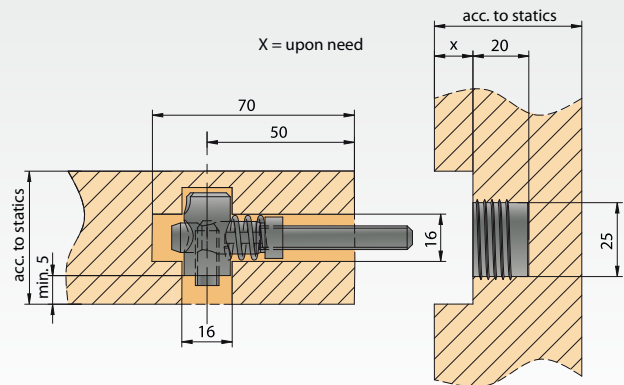

- Applications:** Table leg to table tops and stair tread to stringer connections.
- Advantages:** Non-visible, demountable, self-tightening, strong.
- Suitable materials:** All wood materials (solid and composite).
- Traction strength:** 3 kN
- Installation:** Pre-drill holes and insert connector pieces.
- Mounting:** Attach both components and tighten set screw.

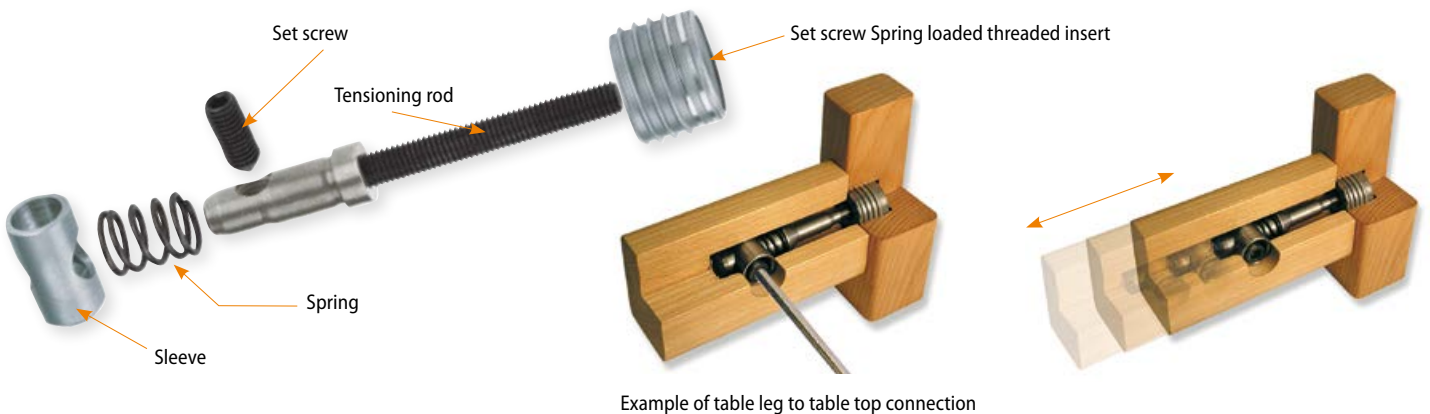

Stair installation: Tread can be mounted both on top or on the side of the stringer.



Screw-in threaded insert (SW 10)



Insert clamping elements in holes



Tighten elements (SW 4)



Stair steps attached and secured, connected with easy-con®

made in Germany



TREPPU



Levelling screw for stair treads



Art.-No. Z300
40 mm



Art.-No. Z310
70 mm



Art.-No. Z320
100 mm

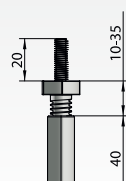

Treppo 40

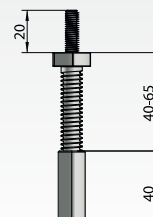

Treppo 70



Treppo 100

Tip: Moisten surface before gluing if wood is very dry..

Applications: Stair tread assembly for new construction and renovations.

Advantages: Height-adjustable mounting screw for steps to compensate for height differences with concrete steps.

Suitable materials: Wood stair treads attached to concrete, stone, and metal.

Installation: Concrete \varnothing 14 mm and If wood \varnothing 6 mm drilling. Bonding with KNAPP®-ADHESIVE PM+ in the borehole.

Mounting: By gluing into the holes with KNAPP®-ADHESIVE PM+.

Accessories: KNAPP®-ADHESIVE PM+ | Art.-No. Z010

Installation



Pre-drill hole



Glue and insert



Transfer bore holes



Glue and assemble



TREPPU

Other assembly or fixing solutions for staircases, balustrades and handrails available:
DUO30 (p.20), ZIPBOLT (p. 34), DUO-System (p. 39), RICON® (p. 48)

KNAPP®-ADHESIVE

One-component polyurethane adhesives



+++ Solvent-free +++ Thixotropic – no drip +++ Coatable ++ +

NEW
glass fibre reinforced

KNAPP®-ADHESIVE PU+ Fibre reinforced

- | Glass fibre reinforced
- | High strength
- | Viscoplastic adhesive joint

KNAPP®-ADHESIVE PU+

- | For thin adhesive joints
- | For smooth surfaces
- | Semi-hard adhesive joint

KNAPP®-ADHESIVE PM+

- | Joint-filling for thick adhesive joints
- | Foams only lightly
- | Strong elastic adhesive joint

Article	KNAPP®-ADHESIVE PU+ Fibre reinforced (Z012)	KNAPP®-ADHESIVE PU+ (Z011)	KNAPP®-ADHESIVE PM+ (Z010)
Application	Craftsmanship, stairs, window, and door construction for universal assembly adhesives in industry and trade, renovations, and overhead installations.	From furniture to window production on smooth surfaces.	For assembly work on uneven surfaces.
Properties	Newly developed polyurethane-based construction adhesive, has a particularly force-reinforcing effect thanks to fibre-glass fibres, water-resistant according to EN 204 class D4.	Easy to use one-component polyurethane adhesive, water-resistant according to EN 204 Class D4.	Easy to use, all purpose, one component polyurethane adhesive, joint-filling, water-resistant according to EN 204 class D4.
Processing	Apply on one side, swells during curing, skin forming time approx. 7 min, functional strength after approx. 20 min, curing time approx. 24 h, processing temperature min. +7 °C, material humidity <8%, bonding tests recommended.	Apply on one side, swells during curing, skin forming time approx. 10 min, functional strength after approx. 20 min, curing time approx. 24 h, processing temperature min. +7 °C, material humidity 8-18%, bonding tests recommended.	Apply on one side, swells during curing, skin forming time approx. 7 min, functional strength after approx. 20 min, curing time approx. 24 h, processing temperature min. +7 °C, material humidity 8-18%, bonding tests recommended.
Materials	Various wood and building materials and ceramics. Gluing of wood e.g. larch and metals e.g. aluminium, copper, brass, thermosets and thermoplastics. Colour: transparent-opaque.	Various types of wood and building materials, as well as plastics, stone, ceramics, metal and KNAPP® connectors, e.g. TREPPO (2-3 cartridges for 100 drill holes). Colour: beige.	A wide variety of wood materials, as well as plastics, stone, metal and all the recommended KNAPP® connectors. Colour: white.

High bonding strength for end grain gluing. Can be subsequently powder-coated (30 min/+200°C)
Polyurethane adhesive - also suitable for sauna construction - Resistant to permanent temperatures up to 120°C.
By using spray mist, the curing time is reduced by 50%.

Bonding Apply to clean, grease- and dust-free surfaces. General processing instructions in the Technical and Safety Data Sheet for download.



KNAPP®-ADHESIVE PU+ is recommended for:

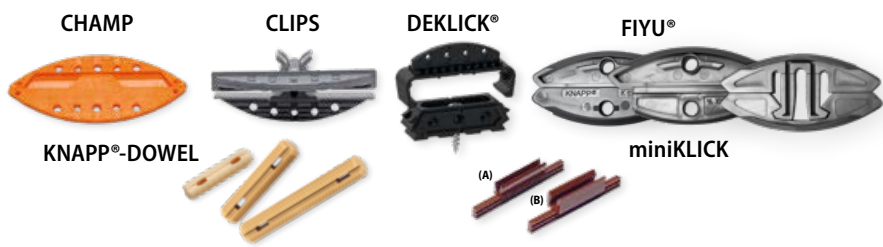

KNAPP®-ADHESIVE PM+ is recommended for TREPPO:



DUO 30, DUO 35



Panel / Hook-in connectors made of steel

Benefits:

- Easy to mount, concealed and immediately load bearing
- Shallow drilling depth – only 3 mm
- Available in Ø 30 and 35 mm
- Optionally mL / oL (with / without sideways tolerance)
- Installed with standard CS-screws or EURO-screws
- Latch the connection with optional locking clip



Installation example:

Fixing of door panel linings, water discharges, decorative parts.

DUO 30 mL

Art.-No. K070



CS-screws 3,5x16 mm
(not included)
Art.-No. Z502

DUO 30 oL

Art.-No. K074

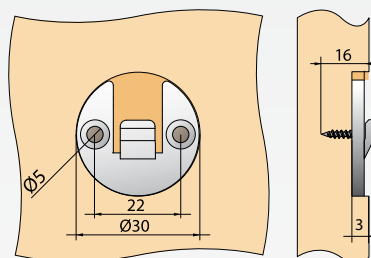

Hooking way 15 mm
Drilling depth 3 mm

DUO 35 mL

Art.-No. K061

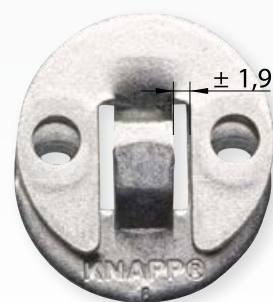

Optimized for CNC-processing:
Euro-screws 6x10 mm

DUO 35 oL

Art.-No. K062

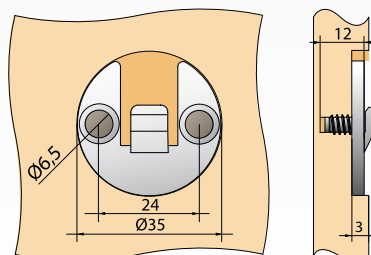
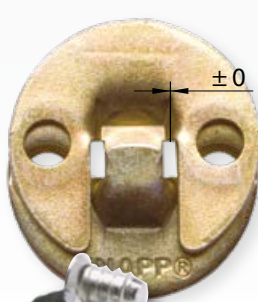

Hooking way 12 mm
Drilling depth 3 mm

Installation example:
Handrail mounting



Applications:	Facades and windows, staircases and handrails, cabinet end panels, door and window casing.
Advantages:	Concealed, self-tightening, demountable connector which allows shrinkage and expansion moving (mL = with tolerances) or for exact placing (oL = with no tolerances).
Suitable materials:	All kinds of wood and particle boards.
Installation:	Drill 3 mm deep holes using the KNAPP® Forstner Bit Ø 30/35 mm with drilling jig or with CNC equipment.
Mounting:	Mount DUO 30 with (suggested) CS-screws 3,5x16 mm / DUO 35 with (suggested) Euro-screws 6x10 mm. Screws length depends on application.
Accessories:	KNAPP® Forstner Bit (Ø 30/35 mm, adjustable depth gauge) Art.-No. Z070 / Art.-No. Z071 Center punch DUO 30/35 Art.-No. K071 / Art.-No. K069, Handrail punch DUO 30 Art.-No. K075 Adjustable boring template DUO 30/35 Art.-No. K563.



DUO 30-35

DUO 30 inox A5



The inox A5 suspension hook connector

Art.-No. K350

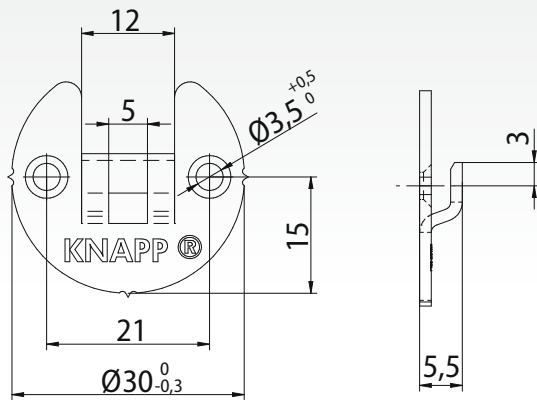

Benefits:

- | Precise and invisible
- | Extremely weatherproof
- | High degree of corrosion resistance (A5)
- | Immediate tensile strength, demountable
- | Easy to install - simple positioning and mechanical retention in the drill hole thanks to the holding tips
- | Easy to fit together without additional tools

- 1 Round shaped steel bracket (A5)
- 2 Positioning and holding tips
- 3 Fix with PH screws 3x13 mm (A2)
- 4 Dovetail hook
- 5 Locking clip (A2)

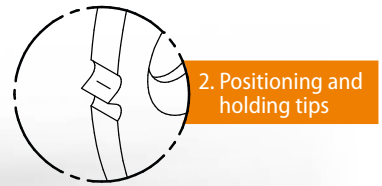
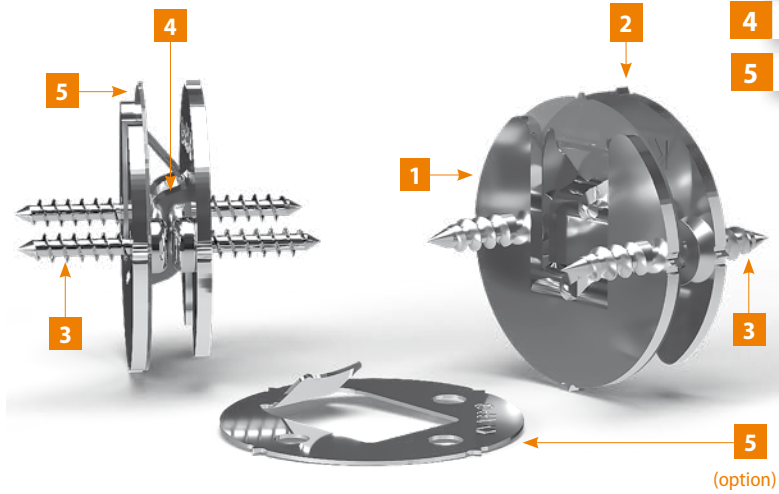

Applications:	For façades, wall and ceiling cladding, panels, mouldings (ship and yacht building, sauna construction, outdoor), and constructions that require a high degree of weathering and corrosion resistance.
Advantages:	Corrosion resistance (A5)
Suitable materials:	All woods, wood-based materials and plastics
Installation:	Screw in with PH screws TCT Forstner drill bit 30 with adjustable brad point, bench drill or CNC
Mounting:	Position, press in and screw or glue together
Accessories:	Locking clip inox (A2) Art.-No. K121, Centre punch DUO 30 Art.-No. K071 PH-screw inox A2 3x13 mm Art.-No. Z631 TCT Forstner drill bit 30 with adjustable brad point (Ø 30 mm) Art.-No. Z070 Drilling template suitable for DUO 30 Art.-No. K563



Installing DUO 30 inox A5



Drilling with template or according to mark



Mark counter part drilling position with centre punch



Install the locking clip to secure the assembly



Position the connector using the holding tips

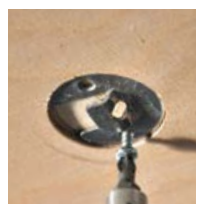

Secure with PH screws

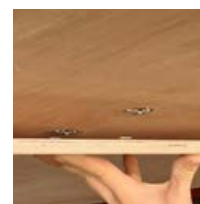

Assemble

UNO 30



Stainless steel A2 hook connector with optional locking clip

Art.-No. K117 UNO 30 inox set

Art.-No. K120/B UNO 30

Art.-No. K120 UNO 30 garniture

(with CS-holding screw 5x50 mm)



PH-screw inox A2 3x13 mm
CS-holding screw A2 5x50 mm

Additional screw lengths
available upon request

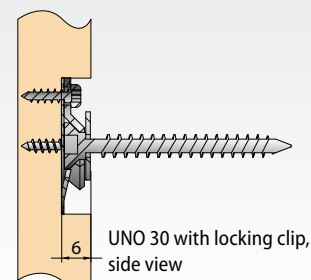

UNO 30 with locking clip,
side view

Applications:	Paneling, facades, handrails, furniture (use with or without locking clip).
Advantages:	Concealed, self tightening, demountable connector for 30 mm drills.
Suitable materials:	All wood materials including concrete and drywall with use of wall anchor.
Installation:	Drill a 7 mm deep hole using the KNAPP Forstner Bit Ø 30 mm using center punch and drilling jig or with CNC.
Mounting:	Screw-fastening with PH-screw Ø 3.5 mm, only 6 mm recess depth.
Accessories:	KNAPP® Forstner bit with adjustable depth stop (Ø 30 mm) Art.-No. Z070 Center punch UNO 30 Art.-No. K073 Adjustable boring template UNO 30 Art.-No. K563



Drill with jig



or according to mark



Screw in the
connector part



Mark counter part
with center punch

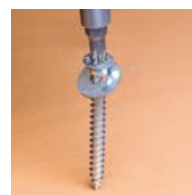

Install with screws



UNO 30

Locking clip

Spring steel locking clip for DUO 30 inox and UNO 30

Art.-No. K121

UNO 30 with locking clip

DUO 30 with locking clip

DUO 30 with locking clip, side view

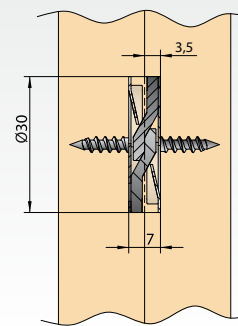
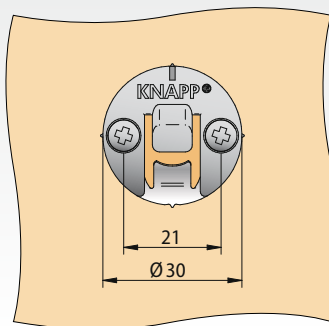
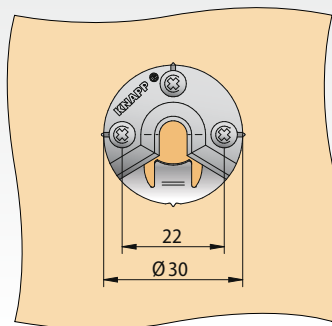
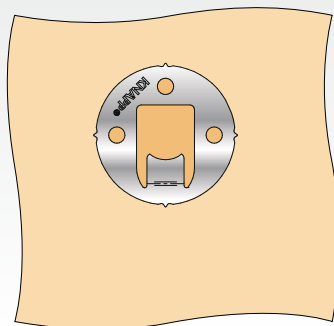

Applications:	For securing joints in the opposite direction to assembly.
Mounting:	Insert beneath DUO 30, DUO 30 inox A5 or UNO 30 bracket prior to mounting with screws.
Advantages:	Locking clip holds up to 24 kg (failure load approx. 73 kg).

TUCK



Spring steel dowels

Art.-No. Z5052	Art.-No. Z5053	Art.-No. Z5055	Art.-No. Z5055B	Art.-No. Z5055A
6x25 mm	8x35 mm	10x32 mm	10x16 mm	10x28 mm

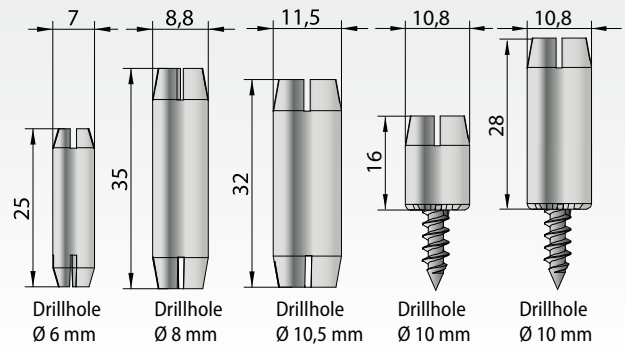

Applications:	Cabinets, case goods, architectural millwork, shop fitting. Anywhere standard wood dowels are used.
Advantages:	Concealed, self-tightening compression dowel, immediately load bearing.
Suitable materials:	All kind of wood materials (solid and composite).
Installation:	Dowel drilling jig, Doweling joiner, CNC drilling.
Mounting:	Insert or screw on the TUCK.



Drill with doweling machine



or doweling joiner



Knock in



or screw



Assemble



TUCK

MILLER DOWEL



Timber pegs for natural wooden furniture

Art.-No. Check online-store

Miller Dowel Mini-X: Ø 6,5x42 mm

Miller Dowel 1x: Ø 10,5x70 mm

Miller Dowel 2x: Ø 12,8x89 mm

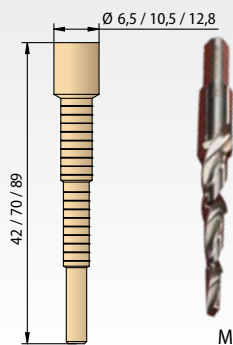

Miller Dowel TruFit Drill Bit

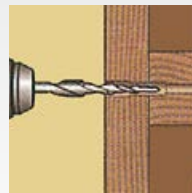

Drill

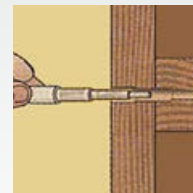

Apply wood glue and position

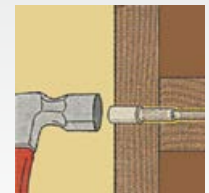

Knock in

Applications:	For connecting ecologically decorative furniture.
Advantages:	Easy installation, decorative design, and ECO - friendly material.
Suitable materials:	Solid wood, plywood, MDF.
Installation:	Drill with custom stepped drill bit, apply adhesive in borehole and insert dowel.
Mounting:	Drill and knock in.
Accessories:	MILLER® TruFit Drill Bit Art.-No. Z01D, Z02D, Z03D (check online-store).



Available in Birch, Oak, American nut and Cherry woods.



Case goods



Load bearing connections



Frame connections



MILLER DOWEL

KNAPP®-DOWEL

Selftightening plastic dowels



Benefits:

- ! Effective prefabrication – doweling jig or automatic doweling machine
- ! Fast installation – connection can be used immediately after insertion
- ! Design - channel along dowel allows for smooth distribution of adhesive and prevents surface from bulging
- ! No shrinking or swelling will occur, thus no risk of breaking or splitting as with wooden dowels
- ! Weather resistant – high quality polyacetal (POM) plastic for interior and exterior use
- ! Strong hold – through additional bonding with KNAPP® ADHESIVE PU+

KNAPP®-DOWEL 6 mm

Art.-No. K066
6x28 mm

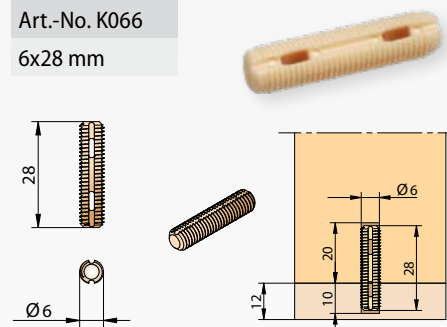

Tip : Moisten the surface of very dry wood before gluing.

KNAPP®-DOWEL 8 mm

Art.-No. K067
8x36 mm

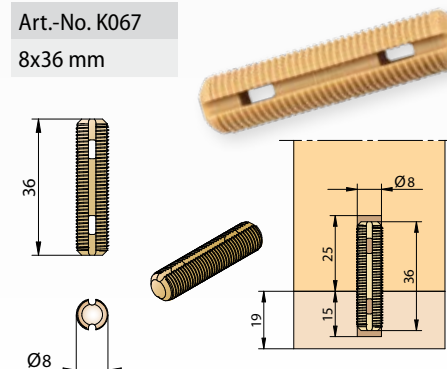

KNAPP®-DOWEL 8 mm

Art.-No. K169
8x50 mm

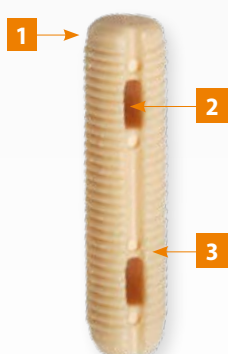
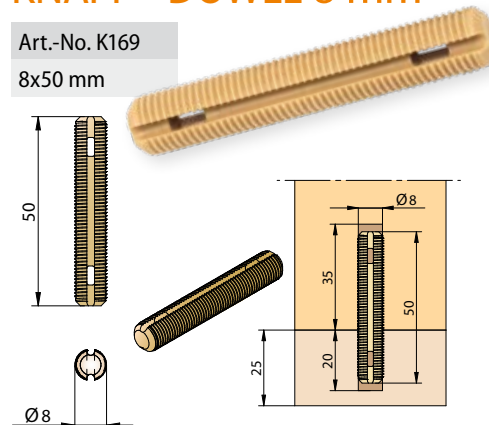

1 High strength and weather-resistant plastic.

2 Slots and longitudinal channels ensure anchoring in tension when using KNAPP®-Adhesive PU+, The adhesive creates a force-locking connection between the components during curing.

3 Threaded design allows for quick installation and unscrewing of KNAPP® Dowel if necessary.



KNAPP
DOWEL

Applications:	Case goods, furniture, architectural millwork and shop fitting, windows. Wherever wood dowels can be used.
Advantages:	UV-resistant, self-tightening dowel.
Suitable materials:	All kind of wood materials (solid and composite).
Installation:	Drill holes with doweling jig or doweling joiner. Insert by hand with hammer or automated dowel insertion machine. Optionally, insert adhesive before inserting dowel.
Mounting:	Gluing with KNAPP®-ADHESIVE PU+.
Accessories:	KNAPP®-ADHESIVE PU+ Art.-No. Z011

Tourillons KNAPP®

Installation



Drill with doweling machine



or doweling joiner



Glue



Knock in

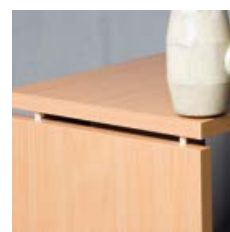

Assemble

Application: Panel materials and example of processing dowel insertion tools



Serial installation of KNAPP® dowels with the dowel insertion machine GANNOMAT Selekt.



Drilling machine GANNOMAT Optima



Dowel inserter GANNOMAT Selekt

KNAPP®-Dowels are also used for wooden windows and doors. Find more details about this application on page 67 and on our website.

Other machine suggestions for the installation of our connectors on page 30.



Outdoor and indoor areas applications: wooden windows, boat, garden furniture, laboratory equipment, door frames



Drill



Glue



Assemble



Boat building



Outdoor furniture

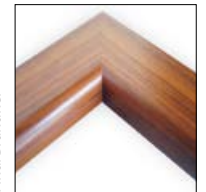

Door frames

QUICK-SET



2-parts dowel connectors

Art.-No. Z5058	Art.-No. Z5056	Art.-No. Z5057	Art.-No. Z5059
5 mm bolt	5 mm bolt	8 mm bolt	8 mm bolt

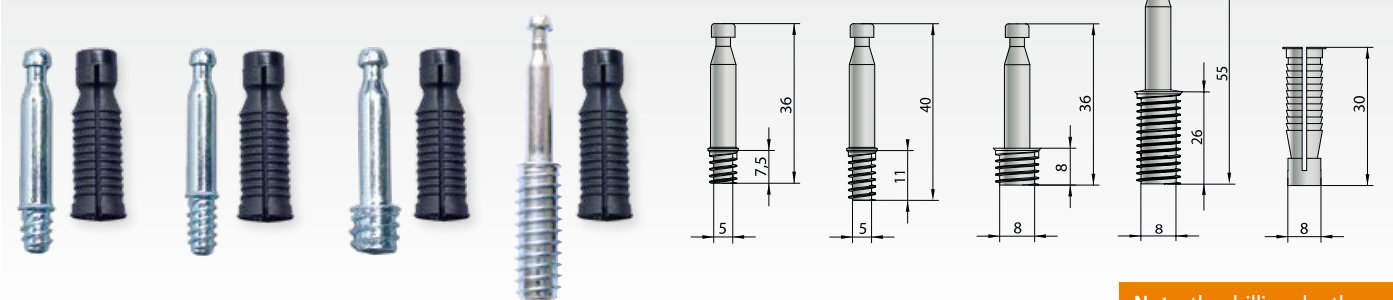

Note: the drilling depth 31 - 32 mm for plastic plugs must be observed to ensure that the system operates correctly.

- Applications:** Furniture, architectural millwork, shop fitting. Wherever wooden dowels are used.
- Advantages:** Concealed, self-tightening, no glue necessary.
- Suitable materials:** All kind of wood materials (solid and composite).
- Installation:** Drill holes with doweling jig or doweling joiner.
- Mounting:** Screw-in threaded stud, then insert plastic sleeve on counter part and insert threaded stud into plastic sleeve.



Drill with doweling machine

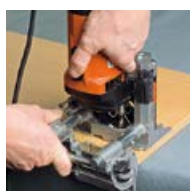

or doweling joiner



Screw-in metal stud



Insert plastic sleeve



Insert plastic sleeve



KLICK



Snap-in dovetail connector, plastic

Art.-No. K045

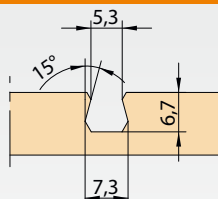
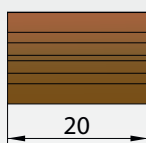
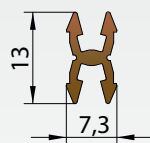

Applications:	Furniture, shopfitting, conceal mouldings or cleats, trims and mitered corners, decorative inserts, ceilings, yacht interiors as well as gluing aid.
Advantages:	Concealed, self-tightening, demountable.
Suitable materials:	All kind of wood materials (solid and composite).
Installation:	Use a router table or CNC to make dovetail router and snap KLICK into groove. Can also be used in combination with KLICKpro.
Mounting:	By hooking into the dovetail groove.
Accessories:	TCT router bits - with \varnothing 6 mm ; \varnothing 6,35 mm and \varnothing 8 mm shank Art.-No. K045/F; K048/F; K046/F

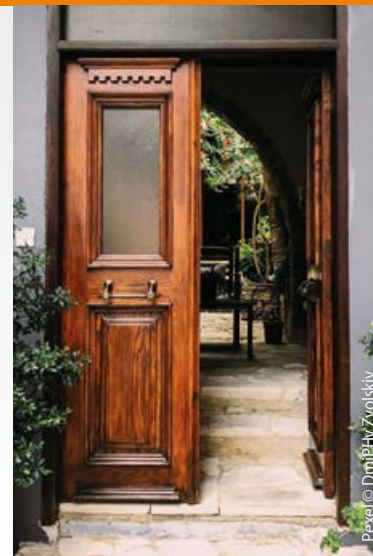

Pixel © Dimpfl+Zvolosky

Installation



Route groove with Gannomat ProTec



Insert



Position/adjust



Snap-in

TCT router bit
with \varnothing 8 mm shank
Art.-No. K046/F



KLICK

sKLICK



Screw-on dovetail connector, plastic incl. PH-screws 3x13 mm

Art.-No. K048

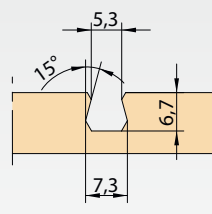
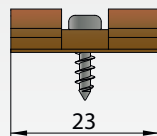
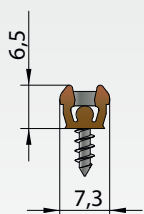

Applications:	Furniture, fittings, fixing mouldings or cleats, decorative inserts, ceilings, yacht interiors as well as gluing aid.
Advantages:	Selftightening, demountable connector for any angles 0-90°.
Suitable materials:	All kind of wood materials (solid and composite).
Installation:	With router, circular saw, portable router or CNC, with the original TCT ROUTER, full-length or spot router - can be combined with KLICKpro.
Mounting:	By fastening with screw.
Accessories:	TCT router bits - with \varnothing 6 mm ; \varnothing 6,35 mm and \varnothing 8 mm shank Art.-No. K045/F; K048/F; K046/F, PH screw 3x13 mm Art.-No. Z600



Solarlux (DE)

Installation



Route groove



Screw-on



Adjust position



Snap-in



S-KLICK

KLICKpro



Dovetail adapter, plastic

Art.-No. K060

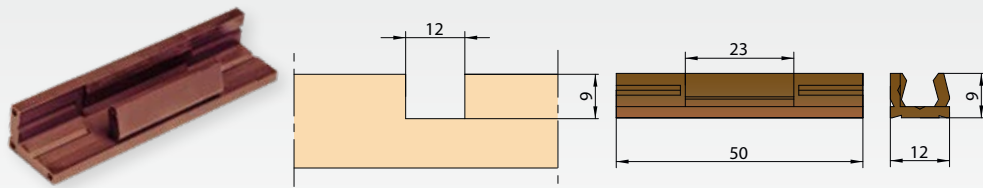

Applications:	Concealed mounting of filler panels, covers and moldings.
Advantages:	Concealed adapter, selftightening dovetail housing suitable for KLICK ou sKLICK.
Suitable materials:	All kind of wood materials (solid and composite).
Installation:	Cut either groove or rebate (9x12 mm by using a spindle moulder or CNC) or install KLICKpro surface mounted.
Mounting:	Fixed KLICKpro by either screwing, nailing or gluing.

Solarlux (DE)

Installation



Route groove



Mount with screws or nails



Snap together



Combinaison sKLICK and KLICKpro



KLICKPRO

miniKLICK



2-parts dovetail snap connector, plastic

Art.-No. K059

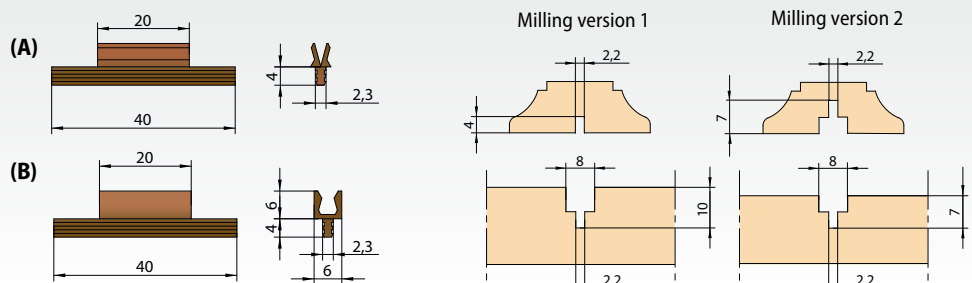
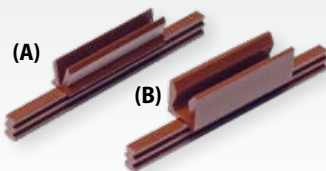

Applications:	Concealed mounting of small moldings and glazing beads e.g. interior doors.
Advantages:	Invisible, self-tightening, removable, space-saving.
Suitable materials:	All kind of wood materials (solid and composite).
Installation:	With spindle moulder and original KNAPP® cutting saw blade (2.2-6x120 mm, with Ø 30 bore).
Mounting:	Gluing into pre-cutted groove with KNAPP®-ADHESIVE PU+.
Accessories:	miniKLICK grooving 120 mm saw blade, Ø 30 mm drillhole Art.-No. Z065 (other Ø on request) Insert tool miniKLICK Art.-No. K068 KNAPP®-ADHESIVE PU+ Art.-No. Z011



Installation



Route groove



Insert



Snap together



Glue (Option)



MINIKLICK

Installation: soulevant coulissant MACO-InfinityView

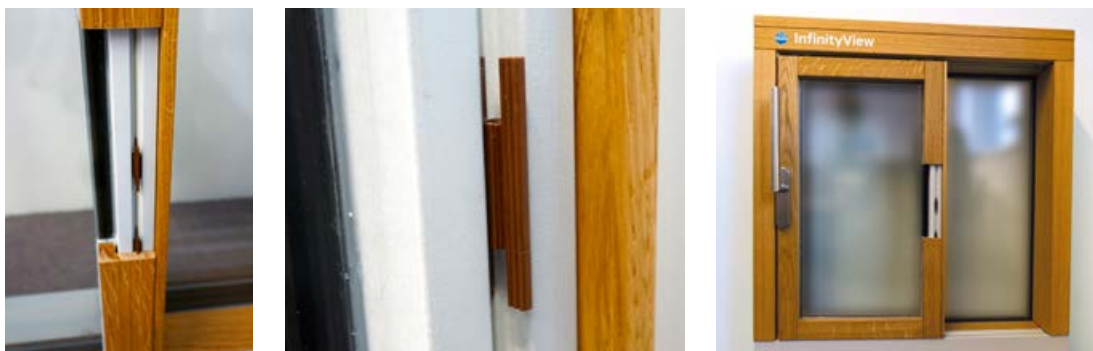

A glass fiber reinforced plastic core, which is covered on the outside with an aluminium shell and on the inside with a wooden frame.

The miniKlick ensures the optimal connection of the wooden sash frame with the glass fiber reinforced plastic core.

Accessories

Lock

- Art.-No. K121 Locking clip (A2)
For securing joists in the opposite direction to insertion, use in combination with UNO 30, DUO 30 and DUO 30 inox A5



Insert Tool

- Art.-No. K049/E Insert tool for driving in KNAPP® connectors (SUNNY, SILVER, FAST and FIYU®)



Allen key with ball end

- Art.-No. Z647 To fasten FIYU® tensioning screws M5x13 mm



Center punches DUO 30/35

- Art.-No. K071 Center punch DUO 30
Art.-No. K075 Handrail punch DUO 30
Art.-No. K069 Center punch DUO 35 with Ø 5 mm for pre-drilling holes for Euro-screws



Center punch UNO 30

- Art.-No. K073 Transfer center mark to opposing wood component when using UNO 30



Square nut DEKCLICK®

- Art.-No. Z896 Square nut M6 DIN 562, zinc-coated steel



KNAPP® Forstner bit Ø 30 mm/35 mm

- Art.-No. Z070 Forstner bit with adjustable depth stop (for UNO 30, DUO 30 and DUO 30 inox A5)
Art.-No. Z072 Forstner bit with adjustable depth stop and adjustable centering point (for UNO 30, DUO 30 and DUO 30 inox A5)
Art.-No. Z071 Forstner bit with adjustable depth stop (for DUO 35)

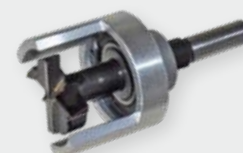

KLICK dovetail router bit and 2 flute straight router bit

- Art.-No. K045/F KLICK router bit with Ø 6 mm shank (to route dovetail KLICK and sKLICK)
Art.-No. K046/F KLICK router bit with Ø 8 mm shank (to route dovetail KLICK and sKLICK)
Art.-No. K048/FQ KLICK router bit with Ø 6,35 mm shank (to route dovetail KLICK and sKLICK)
Art.-No. Z066 2 Flute straight router bit Ø 15 mm, 25 mm length, with Ø 8 mm shank (for CONTRA 800, DUO-System)



Accessories

Routing tools

Art.-No. Z658	Milling cutter DEKCLICK® with profiling knives
Art.-No. Z893	Shank profiling cutter DEKCLICK®
Art.-No. Z065	miniKCLICK grooving saw blade 2.2-6 x 120 mm with Ø 30 mm bore (other Ø on request)
Art.-No. Z894	Grooving cutter DEKCLICK® h20/4 with Ø 30 mm bore (other Ø on request)



Adjustable drill jig

Art.-No. K563	Drilling jig suitable for KNAPP® Forstner bit Ø 30-35 mm to drill holes for DUO 30, DUO 35 and UNO 30
---------------	---



Vis

Art.-No. Z510	Euro screw 6.3x10 mm (for CONTRA, DUO35 and DEKCLICK®)
Art.-No. Z426	Euro screw 6,3x11 mm
Art.-No. Z427	Euro screw 6.3x14 mm
Art.-No. Z518	Euro screw 6,3x30 mm (for CONTRA)
Art.-No. Z600	PH-screw 3x13 mm (for METAL, UNO 30 and sKCLICK)
Art.-No. Z601	PH-screw 3x25 mm (for METAL)
Art.-No. Z502	CS-screw 3.5x16 mm (for DUO 30)
Art.-No. Z422	CS-screw 4x16 mm (for CONTRA and DEKCLICK®)
Art.-No. Z423	CS-screw 4x40 mm (for CONTRA)
Art.-No. Z409	CS-screw inox A2 4.5x35 mm (for KOMBI and DEKCLICK®)
Art.-No. Z514	CS-screw inox A2 5x25 mm with cutter tip (for QUATRO and UNO 30)
Art.-No. Z515	CS-screw inox A2 5x30 mm with cutter tip (for QUATRO and UNO 30)
Art.-No. Z950	CS-screw inox A2 RICON® 5x50 mm (for DEKCLICK® and UNO 30)
Art.-No. K857	Tensioning screw M5x13 mm (for FIYU® LOCK)
Art.-No. Z428	Grub screw M6x12 mm (for FIYU® FAST)

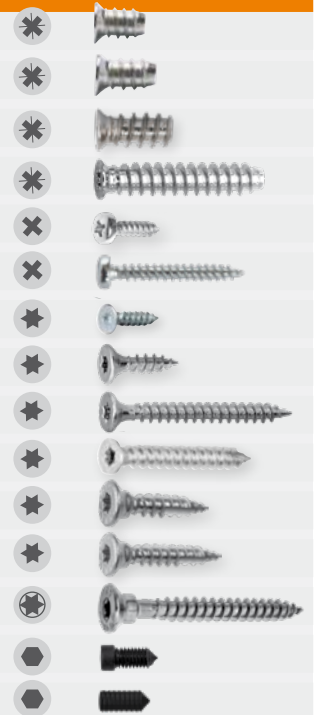

Bits

Art.-No. Z411	Torx bit T15 (for DEKCLICK® and Z-DECK)
Art.-No. Z412	Torx bit T25 (for DEKCLICK® and UNO 30)



Templates, drill bits, adhesives

Art.-No. Z01D, Z02D, Z03D	MILLER® Dowel TruFit Bit Art.-No. Z01D, Z02D, Z03D (see online store)
Art.-No. K617, K618, K619	Drill and test-jig (for positioning and drilling MODULAR) (available in different sizes: M32/11, M44/11, M64/11, see online store)
Art.-No. Z010	KNAPP®-ADHESIVE PM+, see page 19 (TREPPO)
Art.-No. Z011	KNAPP®-ADHESIVE PU+, see page 19 (CHAMP, CLIPS, KOMBI, DEKCLICK®, KNAPP® Dowel, miniKCLICK)
Art.-No. Z012	KNAPP®-ADHESIVE PU+, fibre reinforced, see page 19



Our machine partner

Machining for the implementation of KNAPP® connectors can be carried out in an automated, simple, fast, and professional manner with Gannomat machines.

GANNOMAT

www.GANNOMAT.com



VIDEO

Turning machine and digital drilling machine

GANNOMAT Index



ONE-4-ALL:

Horizontal and vertical drilling
Gluing and insertion of dowels
Horizontal milling with a router bit with shank
Horizontal milling/sawing with a groove cutter



Universal dowelhole drilling machines

GANNOMAT DB 21-27-35



Dowel drilling based on KNAPP® dowels machining and conventional dowels.

Framedrilling, staircasedrilling and mortising machines

GANNOMAT Junior



Drilling and slotted holes for KNAPP® connectors, simple machining, fast and precise, even in solid wood.

CNC machining center

GANNOMAT ProTec



CNC precision machining center for complete processing: drilling, grooving, routing.

ProTec allows compact design and high performance technology with through feed technique for KNAPP® connectors installation in cabinets, furniture, interior design and much more.

Compact - Stronger - Faster.

Gluing and Dowelinserting machines

GANNOMAT SelektA

KNAPP® dowel insertion machine with dowel gun, for use in furniture manufacture, frame assembly and window manufacture.
Gluing and insertion in a single operation.



CONTRA 800

Connector for case goods

Art.-No. K800/B



Screw recommendation

1 EURO-screw CS 6.3x13 mm and
1 EURO-screw CS 6.3x35 mm
(Depending on the requirement,
different lengths can be used)



or

1 vis CS 4.0x16 mm and
1 vis CS 4.0x40 mm
(Depending on the requirement,
different lengths can be used)

- Applications:** The screw connector CONTRA 800 is simply screwed-on and can be used indoors and outdoors. Material thickness as little as 8 mm can be used when CONTRA 800 is combined with Euro-screws. An ideal connector with rebate cuts. CONTRA can be used with Euro screws as little as 6 mm long.
- Advantages:** Fast and versatile - alternative to angle square.
- Suitable materials:** All materials in wood, plastic, steel or masonry.
- Installation:** Only one saw cut or rout a milling or stump screwed on.
- Mounting:** Screw with CS or EURO screw.

Furniture components / corner joints

Recessed on edge in 90°

or

Recessed on face grain in 90°

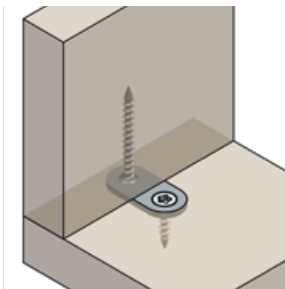
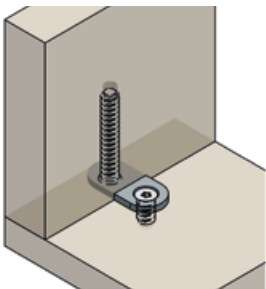

Crown molding and trim

Plinth block

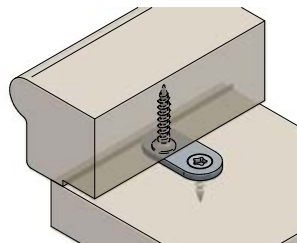

Facades, siding, and decking

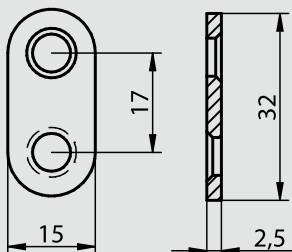
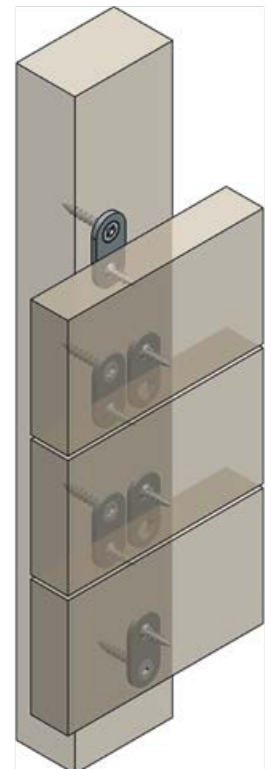

CONTRA 800 dimensions and material:
Length: 32 mm
Width: 15 mm
Thickness: 2.5 mm
Material: steel, blue galvanized surface
(other finishes on request)



Flute Straight Router
Art.-No. Z066



CONTRA

MODULAR



Clip connector, spring steel with shoulder head screw

MODULAR 4031 Pass-thru clip

Art.-No. Z4031



MODULAR 4032 Non-locking clip

Art.-No. Z4032



MODULAR 4035 Semi-locking clip

Art.-No. Z4035



Drill and test-jig

Art.-No. K617 M32/11

Art.-No. K618 M44/11

Art.-No. K619 M64/11

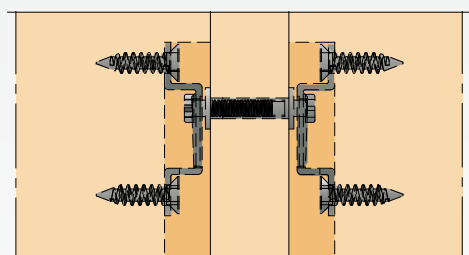
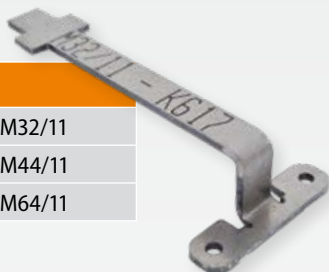

MODULAR double side connection for vertical panels

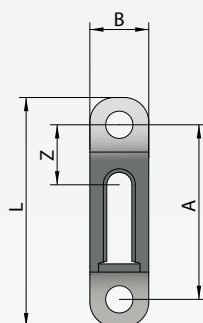

Continuous groove

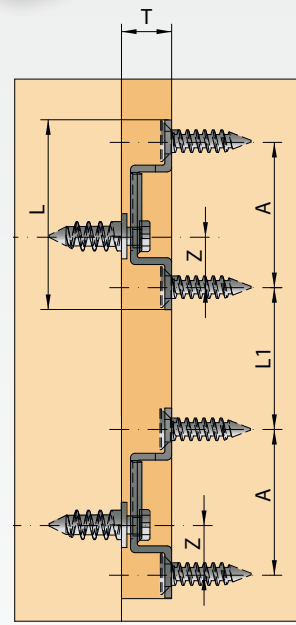
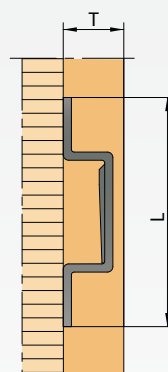

	MODULAR	4031, 4032, 4035
	Panel thickness from	16 mm
A	Hole-line	32 mm
B	Routing width	11 mm
L	Routing length	≥ 42 mm
T	Routing depth	11 mm
Z	Center distance	11 mm



MODULAR clip, suitable with the 32 mm system



Totally concealed installation



MODULAR

NEW

Find all new pieces of MODULAR connectors in our Online-Store!

Applications:	Flat pack, RTA cabinets, case goods, and furniture.
Advantages:	Concealed, self-tightening connector for 32 mm system, demountable, for timber and steel.
Suitable materials:	For all solid wood, wood based panels and plastic materials from 16 mm thickness up.
Installation:	Make groove with spindle moulder, plunge router, CNC equipment. Pre-drill with drill-jig. and install clips.
Mounting:	Install clips with PH or CS-screws up to Ø 4.5 mm (length depending on application) Shoulder head screw engages with the clip when sliding them into each other.
Accessories:	Drill and test-jig Art.-No. K617 (M32/11), Art.-No. K618 (M44/11), Art.-No. K619 (M64/11)

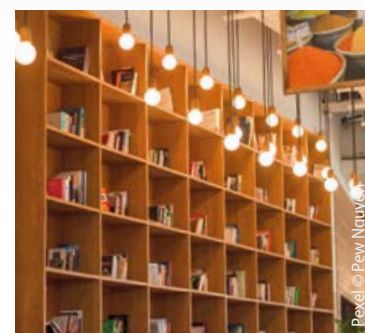

MODULAR shoulder head screw

Shoulder head screws

MODULAR 2055

Art.-No. Z2055



Height de filetage : 13 mm

MODULAR 2155

Art.-No. Z2155



16 mm

MODULAR 5068

Art.-No. Z5068



32 mm

Double side connection

Shoulder head screws M4

MODULAR 2069

Art.-No. Z2069



15 mm

MODULAR 2066

Art.-No. Z2066



16 mm

MODULAR Anti-Torsion



Anti-rotation spring steel clip with integrated stop

MODULAR 2075

Art.-No. Z2075

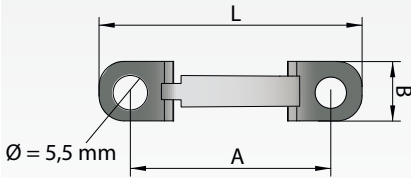

For PH or CS-screws up to Ø 4.5 mm

MODULAR 2076

Art.-No. Z2076

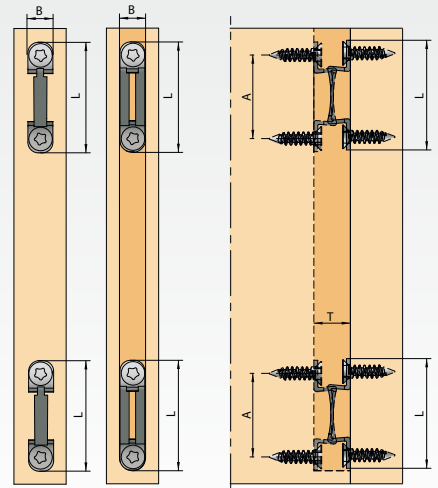
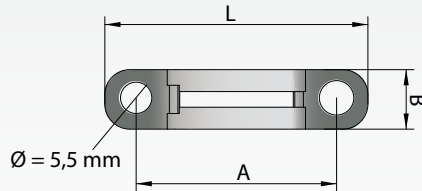

Assembling cabinet body with MODULAR

MODULAR 5075
(w/ integrated stop)

Art.-No. Z5075

MODULAR 5071
(w/o integrated stop)

Art.-No. Z5071

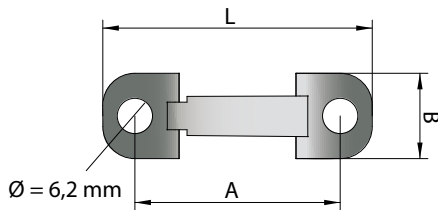

For PH or CS screws up to Ø5 mm.

MODULAR 5076
(matching Art.-No. Z5075)

Art.-No. Z5076

MODULAR 5072
(matching Art.-No. Z5071)

Art.-No. Z5072

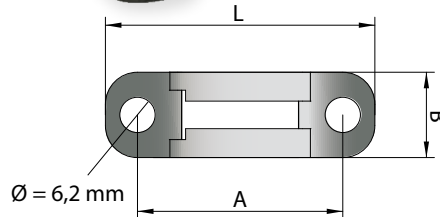

Connexion de cadres avec MODULAR

	MODULAR	2075, 2076	5071, 5072, 5075, 5076
Panel thickness from		16 mm	19 mm
A Hole-line		32 mm	32 mm
B Routing width		10 mm	13.5 mm
L Routing length		42 mm	42 mm
T Routing depth		14 mm	12 mm



LOUIS, (FR) © Briag Courteaux

- Applications:** Frames, chairs, furniture, cabinets, bookcases and shelving with heavy loads, fittings.
- Advantages:** No rotation, concealed, self-tightening connector for 32 mm system, demountable.
- Suitable materials:** For all solid wood, wood based panels and plastic materials from 16 mm thickness up.
- Installation:** Make groove with spindle moulder, horizontal router table, CNC equipment.
- Mounting:** Pre-drill with drill-jig and install clips with PH or CS-screws Ø 4.5 mm (length depending on application).

Installation



Route groove



Check width



Mark position



Install clip



Install SH screw

Zipbolt™ 90 KD

(M = Drilling depth)



Joint connector for frames ≥ 22 mm

Art.-No. Z372

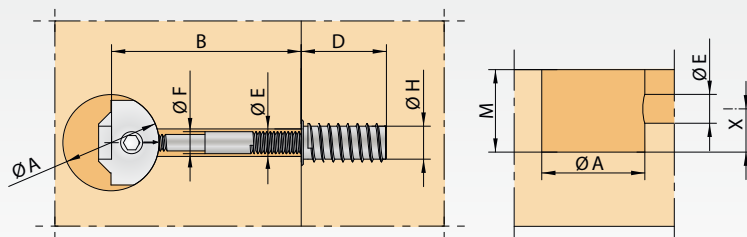
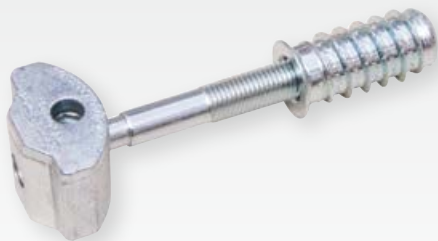

With metal housing:

Load capacity up to 60 kg tension load (failure load approx. 100 kg)

M	X	Ø A	B	D	Ø H	Ø F	E
20 mm	10 mm	35 mm	60-65 mm	32 mm	12 mm	8 mm	9 mm

Applications:	Frame connector for beds and RTA furniture.
Advantages:	Fast and easily installed by using a SW5 hex bit in conjunction with cordless drill.
Suitable materials:	For all solid wood and wood based panels.
Installation:	Pre-drill holes using plunge router or CNC.
Mounting:	Insert connector parts into holes and assemble.



ZIPBOLT



ZIPBOLT™ 85



Joint connector for countertops ≥ 22 mm

Art.-No. Z358

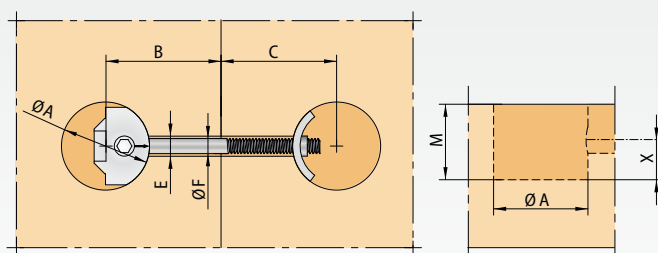

With metal housing:

Load capacity up to 60 kg tension load (failure load approx. 100 kg)

M	Length	X	Ø A	B	C	Ø F	E
20 mm	85 mm	10 mm	35 mm	33-44 mm	33-44 mm	6 mm	8 mm

Applications:	Joint connector for worktops, countertops and panels.
Advantages:	Fast and easily installed by using a SW5 hex bit and a cordless drill.
Suitable materials:	For all solid wood and wood based panels.
Installation:	Pre-drill holes using plunge router or CNC.
Mounting:	Insert connector parts into holes and assemble.



ZIPBOLT™ 120

(M = Drilling depth)



Joint connector for countertops ≥ 22 mm

Art.-No. Z366

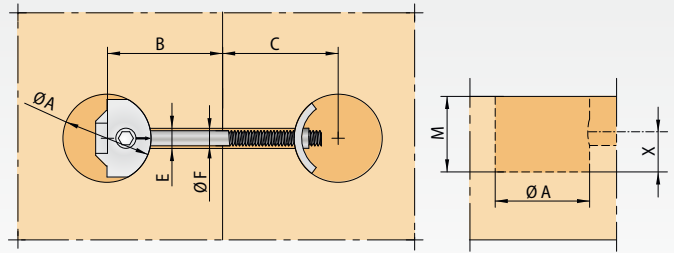

With metal housing:
Load capacity up to 60 kg tension load (failure load approx. 100 kg)

M	Length	X	Ø A	B	C	Ø F	E
20 mm	120 mm	10 mm	35 mm	50-62 mm	50-62 mm	6 mm	8 mm

- Applications:** Joint connector for worktops, countertops and panels.
- Advantages:** Fast and easily installed by using a SW5 hex bit SW5 and a cordless drill.
- Suitable materials:** All kind of wood materials (solid and composite).
- Installation:** Pre-drill holes using plunge router or CNC.
- Mounting:** Insert connector parts into holes and assemble.



ZIPBOLT™ 170



Joint connector for countertops ≥ 22 mm

Art.-No. Z367

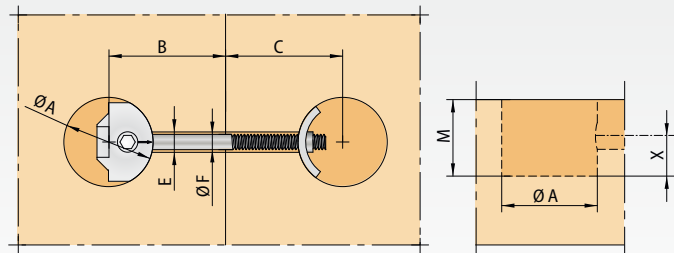

With metal housing:
Load capacity up to 60 kg tension load (failure load approx. 100 kg)

M	Length	X	Ø A	B	C	Ø F	E
20 mm	170 mm	10 mm	35 mm	74-87 mm	74-87 mm	6 mm	8 mm

- Applications:** Joint connector for worktops, countertops and panels.
- Advantages:** Fast and easily installed by using a SW5 hex bit and a cordless drill.
- Suitable materials:** For all solid wood and wood based panels.
- Installation:** Pre-drill holes using plunge router or CNC.
- Mounting:** Insert connector parts into holes and assemble.



ZIPBOLT™ 100 MINI

(M = Drilling depth)



Joint connector for countertops ≥ 16 mm

Art.-No. Z355



With metal housing:
Load capacity up to 60 kg tension load (failure load approx. 100 kg)

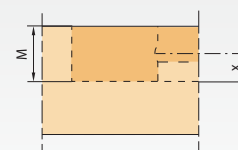
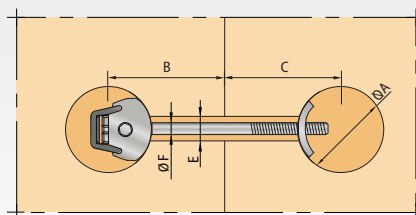

M	Length	X	Ø A	B	C	Ø F	E
13 mm	100 mm	7 mm	25 mm	42-49 mm	42-49 mm	7 mm	11 mm

Applications: Countertop and panel connectors for straight butt joints.

Advantages: Fast and easily installed by using a SW4 hex bit and a cordless drill.

Suitable materials: All kind of wood materials (solid and composite).

Installation: Pre-drill holes using plunge router or CNC.

Mounting: Insert connector parts into holes and assemble.



ZIPBOLT™ 100 MINI ULPHA SLIM



Joint connector for countertops ≥ 13 mm

Art.-No. Z373



With metal housing:
Load capacity up to 60 kg tension load (failure load approx. 100 kg)

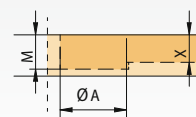
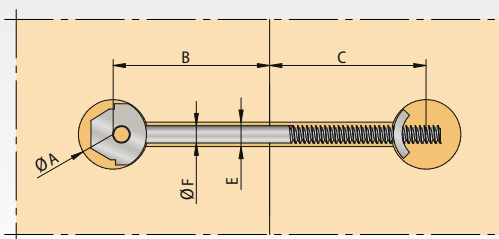

M	Length	X	Ø A	B	C	Ø F	E
10 mm	100 mm	8 mm	20 mm	43-50 mm	43-50 mm	4 mm	8 mm

Applications: Countertop and panel connectors for straight butt joints.

Advantages: Fast and easily installed by using a TX25 Torx bit and a cordless drill.

Suitable materials: All kind of wood materials (solid and composite).

Installation: Pre-drill holes using plunge router or CNC.

Mounting: Insert connector parts into holes and assemble.



ZIPBOLT™ MINI UT 30 KD



Joint connector for countertops ≥ 16 mm

Art.-No. Z376

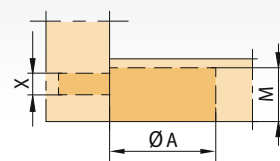
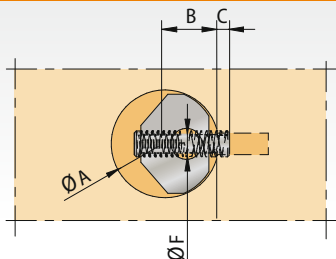

M	Length	X	Ø A	B	C	Ø F	E
12,8 mm	30 mm	5 mm	25 mm	12 mm	12 mm	5 mm	5 mm

Applications: Countertop and panel connectors for straight butt joints.

Advantages: Fast and easily installed by using a SW4 hex bit and a cordless drill.

Suitable materials: All kind of wood materials (solid and composite).

Installation: Pre-drill holes using plunge router or CNC.

Mounting: Insert connector parts into holes and assemble.

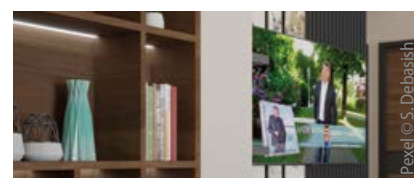

ZIPBOLT™ MINI UT 43 KD

(M = Drilling depth)



Joint connector for countertops ≥ 16 mm

Art.-No. Z377

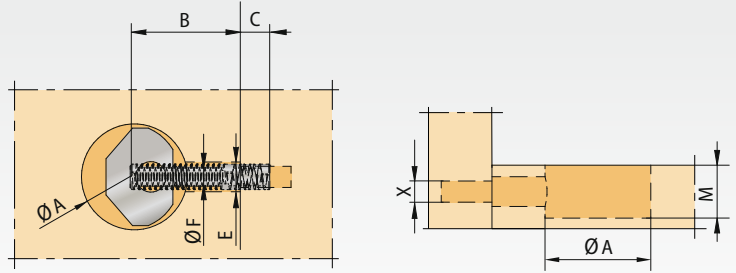

M	Length	X	Ø A	B	C	Ø F	E
12,8 mm	43 mm	5 mm	25 mm	25 mm	12 mm	6 mm	7 mm

- Applications:** Countertop and panel connectors for straight butt joints.
- Advantages:** Fast and easily installed by using a SW4 hex bit and a cordless drill.
- Suitable materials:** All kind of wood materials (solid and composite).
- Installation:** Pre-drill holes using plunge router or CNC.
- Mounting:** Insert connector parts into holes and assemble.



ZIPBOLT™ SLIPFIX RAILBOLT



90° handrail connector

Art.-No. Z374

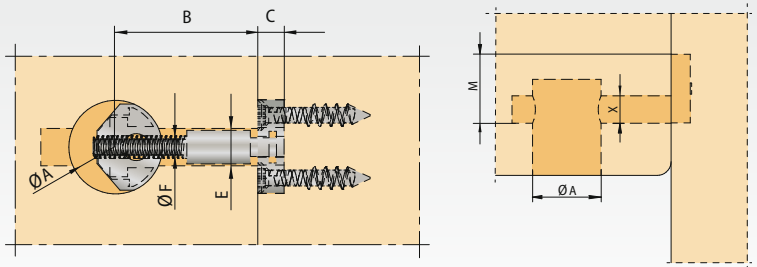

M	Length	X	Ø A	B	C	Ø F	E
35 mm	49 mm	10 mm	25 mm	± 38 mm	7 mm	6	9,5-10 mm

- Applications:** Countertop and panel connectors for straight butt joints.
- Advantages:** Fast and easily installed by using a 5mm hex bit and a cordless drill.
- Suitable materials:** All kind of wood materials (solid and composite).
- Installation:** Pre-drill holes using plunge router or CNC.
- Mounting:** Insert connector parts into holes and assemble.



ZIPBOLT™ EXTERIOR SLIPFIX



Exterior 90° handrail connector

Art.-No. Z378

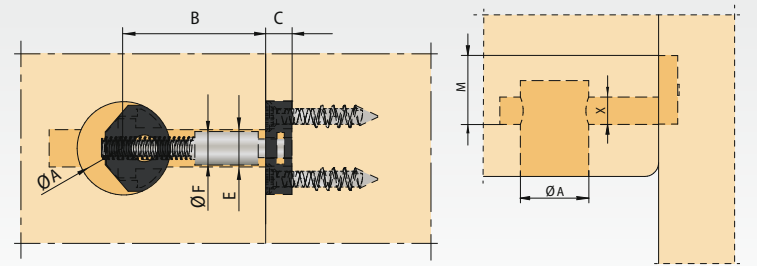

M	Length	X	Ø A	B	C	Ø F	E
35 mm	49 mm	10 mm	25 mm	± 38 mm	7 mm	6	9,5-10 mm

- Applications:** Countertop and panel connectors for straight butt joints.
- Advantages:** Fast and easily installed by using a 5mm hex bit and a cordless drill.
- Suitable materials:** All kind of wood materials (solid and composite).
- Installation:** Pre-drill holes using plunge router or CNC.
- Mounting:** Insert connector parts into holes and assemble.

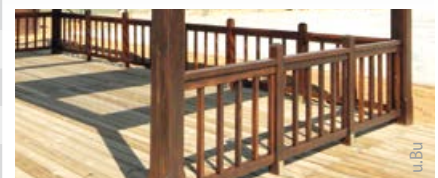

ZIPBOLT™ UT POST ANCHOR

Post connector

Art.-No. Z381

NEW

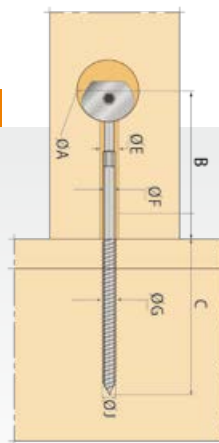

(M = Drilling depth)



G = 13,5 | J = +/- 10 mm

M	Height	X	Ø A	B	C	Ø F	E
> 28 mm	260 mm	14 mm	35 mm	125 mm	143 mm	11 mm	13 mm

- Applications:** Fixing staircase posts.
- Advantages:** Fast and easily installed by using a T40 Torx Bit and a cordless drill.
- Suitable materials:** All kind of solid wood materials.
- Installation:** Pre-drill holes using plunge router or CNC.
- Mounting:** Insert connector parts into holes and assemble.

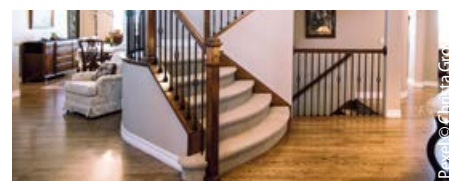

ZIPBOLT™ XT POST ANCHOR

External post

connector

Art.-No. Z379



NEW

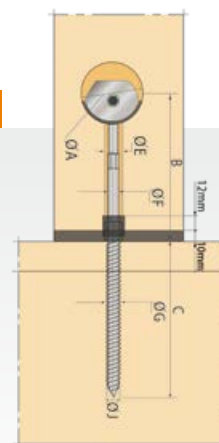

G = 13,5 | J = +/- 10 mm

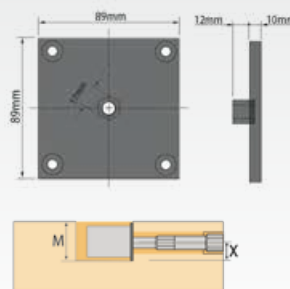

M	Height	X	Ø A	B	C	Ø F	E
37 mm	260 mm	18 mm	38 mm	124 mm	130 mm	11mm	16 mm

- Applications:** Connection for external posts on terraces and verandas.
- Advantages:** Fast and easily installed by using a 6mm hex bit and a cordless drill.
- Suitable materials:** All kind of solid wood materials.
- Installation:** Pre-drill holes using plunge router or CNC.
- Mounting:** Insert connector parts into holes and assemble.

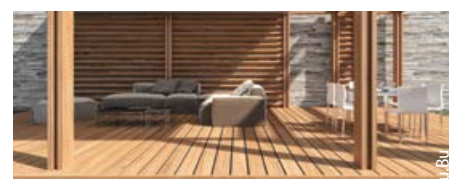

Application examples



DUO-System



Frame connectors



Applications:	Furniture frames, stairs, exhibition booths, and architectural millwork.
Advantages:	Invisible, self-tightening, adjustable assembly pressure thanks to the fixing screw. Only 13 mm recess depth.
Suitable materials:	All solid wood and plywood materials from ≥ 21 mm.
Installation:	Make mortise with plunge router or CNC.
Mounting:	Install with CS-screws $\varnothing 5$ mm or $\varnothing 6$ mm (screw length depending on application) and PH-holding screws $\varnothing 5$ mm or $\varnothing 6$ mm.
Note:	The system consists of two identical brackets and are manufactured from high strength galvanized steel in Austria.

Accessories

Routing-jigs MULTI F (plywood)

- Routing-jig MULTI F15, | Art.-No. K500 (for DUO 46/15, DUO 62/15, DUO 100/15)
- Routing-jig MULTI F20, | Art.-No. K506 (for DUO 90/20)
- Routing-jig MULTI F30, | Art.-No. K501 (for DUO 46/30, DUO 62/30)
- Routing-jig MULTI F46, | Art.-No. K503 (for DUO 90/46)

Remarque : All routing-jigs are suitable for a $\varnothing 30$ mm guide bushing (for plunge router) and a $\varnothing 15$ mm 2 Flute Straight Router Bit.

2 flute straight router bit $\varnothing 15$ mm, 25 mm length with $\varnothing 8$ mm shank | Art.-No. Z066

Mounting screws - pan-head screws, full threaded (PH - FT)

- PH-screw 5x40 (200 pcs./package) | Art.-No. Z702 (for DUO and MODULAR Anti-Torsion)
- PH-screw 5x60 (200 pcs./package) | Art.-No. Z704 (for DUO and MODULAR Anti-Torsion)
- PH-screw 6x40 (250 pcs./package) | Art.-No. Z800 (for DUO)
- PH-screw 6x60 (200 pcs./package) | Art.-No. Z802 (for DUO)

Mounting screws - countersunk screws, full threaded (CS - FT)

- CS-screws 5x40 (500 pcs./package) | Art.-No. Z500 (for DUO and ACRO)
- CS-screws 5x60 (250 pcs./package) | Art.-No. Z498 (for DUO, ACRO and BASIS)
- CS-screws 6x40 (250 pcs./package) | Art.-No. Z501 (for DUO and ACRO)
- CS-screws 6x60 (200 pcs./package) | Art.-No. Z499 (for DUO, ACRO and BASIS)

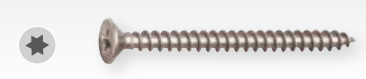

Installation



Route mortise



Screw in a

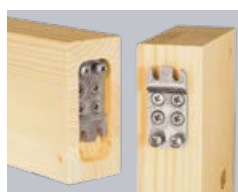

Screw in b

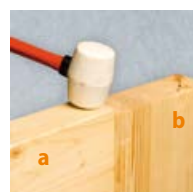

Assemble



DUO-SYSTEM

DUO 26

DUO 26/26

Art.-No. K047

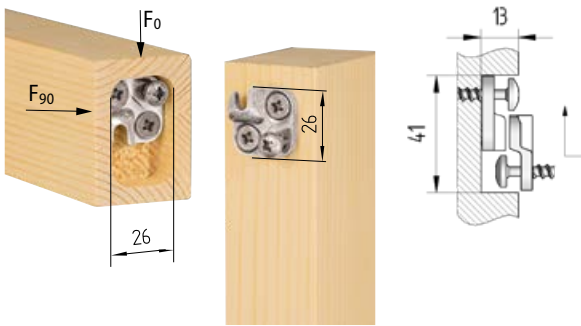

Mounting screws	5x40	5x60	Load capacity		
			zul F ₀	zul F ₉₀	
PH - FT	1	1	Slide-in direction	Right angle to slide-in direction	
CS - FT	2	2	0.97 kN	1.07 kN	
Recommended timber dimension			Size of rebate		
Width/Height: 50x50 mm			Width	Height	Depth
			26 mm	41 mm	13 mm

DUO Serie 15

DUO 46/15

Art.-No. K041

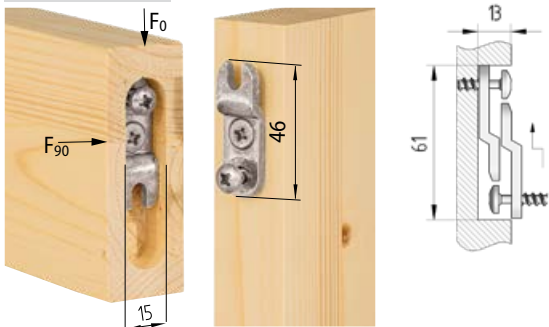

Mounting screws	5x40	5x60	Load capacity		
			zul F ₀	zul F ₉₀	
PH - FT	1	1	Slide-in direction	Right angle to slide-in direction	
CS - FT	1	1	0.86 kN	0.62 kN	
Recommended timber dimension			Size of rebate		
Width/Height: 30/80 mm			Width	Height	Depth
			15 mm	61 mm	13 mm

DUO 62/15

Art.-No. K036

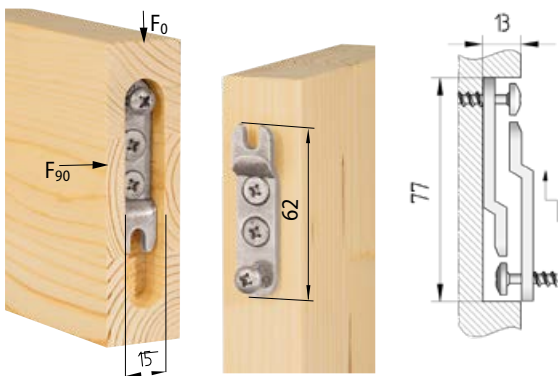

Mounting screws	5x40	5x60	Load capacity		
			zul F ₀	zul F ₉₀	
PH - FT	1	1	Slide-in direction	Right angle to slide-in direction	
CS - FT	2	2	1.29 kN	0.71 kN	
Recommended timber dimension			Size of rebate		
Width/Height: 30/100 mm			Width	Height	Depth
			15 mm	77 mm	13 mm

DUO 100/15

Art.-No. K055

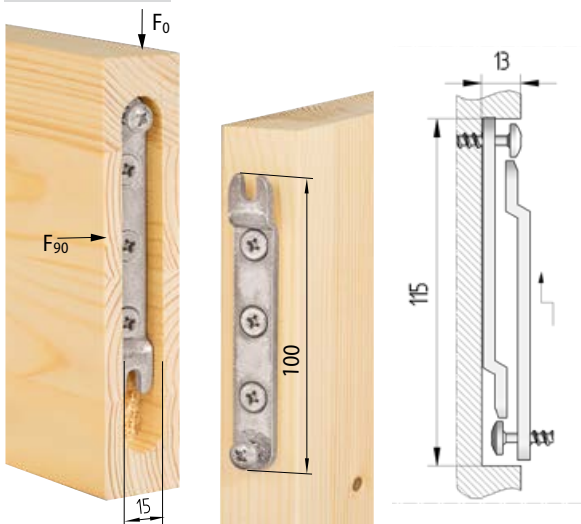

Mounting screws	5x40	5x60	Load capacity		
			zul F ₀	zul F ₉₀	
PH - FT	1	1	Slide-in direction	Right angle to slide-in direction	
CS - FT	3	3	2.00 kN	0.92 kN	
Recommended timber dimension			Size of rebate		
Width/Height: 30/140 mm			Width	Height	Depth
			15 mm	115 mm	13 mm

DUO Serie 30

DUO 46/30

Art.-No. K046

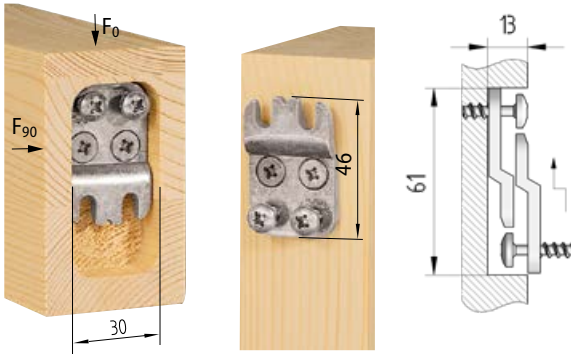

Mounting screws	5x40	5x60	Load capacity	
			zul F ₀	zul F ₉₀
PH - FT	2	2	Slide-in direction	Right angle to slide-in direction
CS - FT	2	2	1.30 kN	1.12 kN
Recommended timber dimension			Size of rebate	
Width/Height: 50/80 mm			Width	Height
			30 mm	61 mm

DUO 62/30

Art.-No. K022

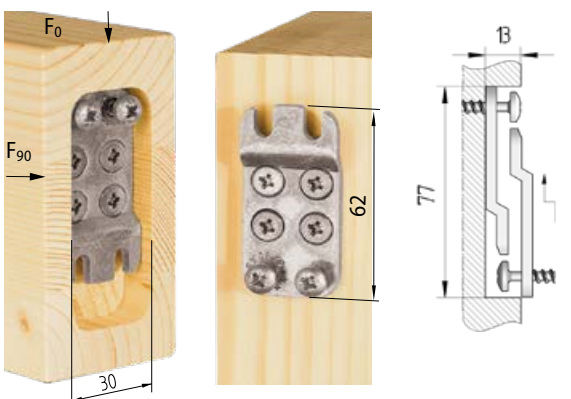

Mounting screws	5x40	5x60	Load capacity	
			zul F ₀	zul F ₉₀
PH - FT	2	2	Slide-in direction	Right angle to slide-in direction
CS - FT	4	4	2.15 kN	1.67 kN
Recommended timber dimension			Size of rebate	
Width/Height: 50/100 mm			Width	Height
			30 mm	77 mm

DUO 20 and 46

DUO 90/20

Art.-No. K037

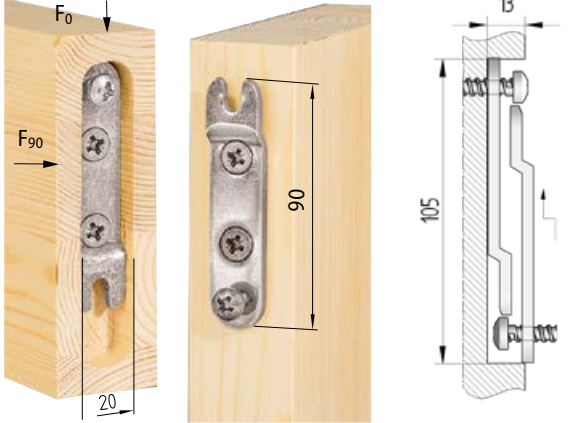

Mounting screws	6x40	6x60	Load capacity	
			zul F ₀	zul F ₉₀
PH - FT	1	1	Slide-in direction	Right angle to slide-in direction
CS - FT	2	2	2.37 kN	1.03 kN
Recommended timber dimension			Size of rebate	
Width/Height: 40/120 mm			Width	Height
			20 mm	105 mm

DUO 90/46

Art.-No. K040

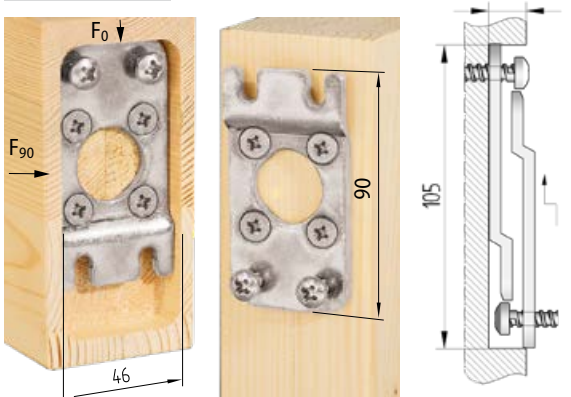

Mounting screws	6x40	6x60	Load capacity	
			zul F ₀	zul F ₉₀
PH - FT	2	2	Slide-in direction	Right angle to slide-in direction
CS - FT	4	4	4.35 kN	2.28 kN
Recommended timber dimension			Size of rebate	
Width/Height: 60/120 mm			Width	Height
			46 mm	105 mm

The load value refers to the shear force in the insertion direction. Commercially available CS-screws and PH-screws (5x40, 5x60, 6x40, 6x60 mm) in accordance with ÖNORM M 5027 must be used in DUO systems. The test was carried out by Holzforschung Austria.

Solid



Wooden connector (metal-free) for bed rails



Solid connector © Schreineri Rainer Groh

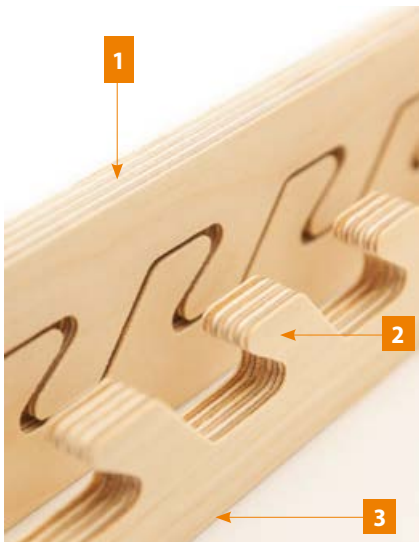

1 The birch multiplex connector reduces mechanical stresses thanks to its self-locking notched hook principle, guaranteeing stable, play-free assembly.

2 The connector can be bonded with KNAPP®-ADHESIVE PU+ to optimise its strength. Once the adhesive has set, the connector is ready for use.

3 The flush-fitting groove should be approximately 1 to 2 mm deeper than the width of the connector to allow room for excess adhesive.

Benefits:

- | Rigid material
- | Metal-free
- | Highly stable junction
- | Easy to assemble
- | Tool-free disassembly and refitting
- | Invisible after final assembly
- | Cost-effective

Applications: Assembling bed frames without metal parts or screws, furniture, lightweight wooden constructions.

Advantages: The use of birch multiplex material reduces mechanical stress, making for a very stable assembly. Tool-free mounting and dismounting.

Suitable materials: Multiplex birch in thicknesses of 8, 12 and 15 mm x width 40 mm. Groove depth is 32 mm.

Technical data : Recommended timber dimension ≥ 32 mm.

Installation: Quick and easy machining with the right cutters and milling jigs.

Mounting: By gluing in the groove with white glue or KNAPP® ADHESIVE PU+.

Accessories: **Solid S** Routing-jig 8/12/15 x 118 mm | Art.-No. Z979, Z980, Z981

Solid M Routing-jig 8/12/15 x 164 mm | Art.-No. Z982, Z983, Z984

Solid L Routing-jig 8/12/15 x 210 mm | Art.-No. Z982, Z983, Z984

2 flute straight router 8 mm | Art.-No. Z988, 12 mm | Art.-No. Z989, 15 mm | Art.-No. Z990

Available in 9 variants (3 lengths and 3 thicknesses)

Art.-No. Z970, Z971, Z972

Art.-No. Z973, Z974, Z975

Art.-No. Z976, Z977, Z978

| Solid S

| Solid M

| Solid L



118



164



210

Light timber structures

**Column/Post and beam
mounting connectors**



ACRO-System



Frame, post and beam connectors.

Applications:	Post and beam joints for light timber construction.
Advantages:	Invisible, self-tightening, very shallow recess depth (8.5 mm).
Suitable materials:	Solid wood material.
Installation:	Mill pocket with plunge router and MULTI F routing jig.
Mounting:	Install connector with countersunk screws, full threaded (CS - FT) \varnothing 5 mm ou \varnothing 6 mm and PH-holding screws \varnothing 5 mm or \varnothing 6 mm (screw length depending on application).
Accessories:	2 Flute Straight Router Bit Art.-No. Z066, routing-jig MULTI F, marking template, Various CS-screw lengths available on demand.



ACRO Serie 47

ACRO 46/47

Art.-No. K042

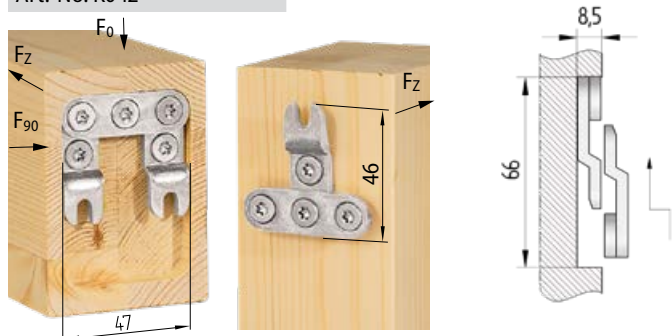

Mounting screws	5x40	5x60	Load capacity		
			zul F_0	zul F_{90}	zul F_z
CS - FT	4	5	Slide-in direction	Right angle to slide-in direction	Traction
			1.43 kN	0.98 kN	1.93 kN
Recommended timber dimension			Size of rebate		
Width/Height: 60/80 mm			Width	Height	Depth
			47 mm	66 mm	8,5 mm

ACRO 62/47

Art.-No. K033

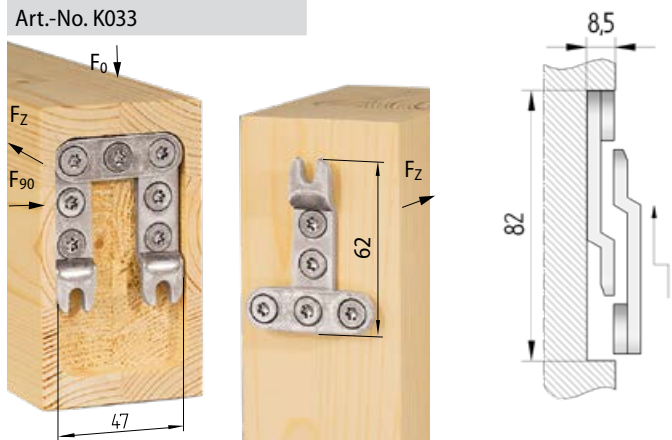

Mounting screws	5x40	5x60	Load capacity		
			zul F_0	zul F_{90}	zul F_z
CS - FT	5	7	Slide-in direction	Right angle to slide-in direction	Traction
			2.47 kN	1.64 kN	1.55 kN
Recommended timber dimension			Size of rebate		
Width/Height: 60/100 mm			Width	Height	Depth
			47 mm	82 mm	8,5 mm

ACRO 100/47

Art.-No. K057

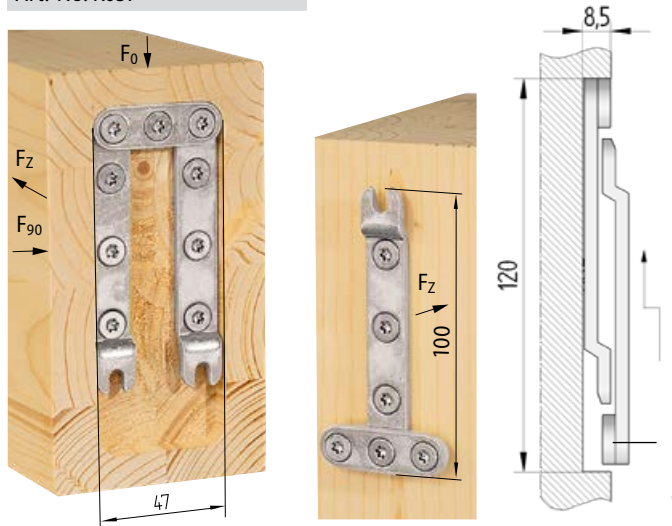

Mounting screws	5x40	5x60	Load capacity		
			zul F_0	zul F_{90}	zul F_z
CS - FT	6	9	Slide-in direction	Right angle to slide-in direction	Traction
			4.14 kN	2.78 kN	1.75 kN
Recommended timber dimension			Size of rebate		
Width/Height: 75/135 mm			Width	Height	Depth
			47 mm	120 mm	8.5 mm

Note: It is possible to adjust the height of the attachment screws and therefore the assembly pressure.

ACRO Serie 62

ACRO 46/62

Art.-No. K043

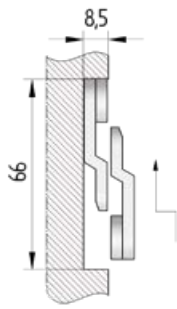
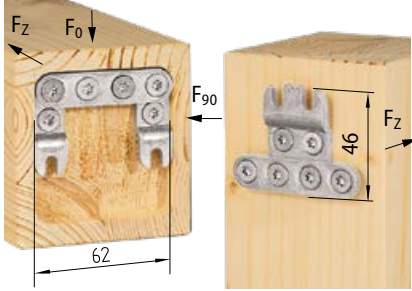

Mounting screws	5x40	5x60	Load capacity		
			zul F ₀	zul F ₉₀	zul F _Z
CS - FT	6	6	Slide-in direction	Right angle to slide-in direction	Traction
			2.11 kN	1.55 kN	2.85 kN

Recommended timber dimension	Size of rebate		
	Width	Height	Depth
Width/Height: 80/80 mm	62 mm	66 mm	8.5 mm

ACRO 62/62

Art.-No. K031

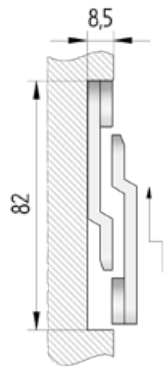
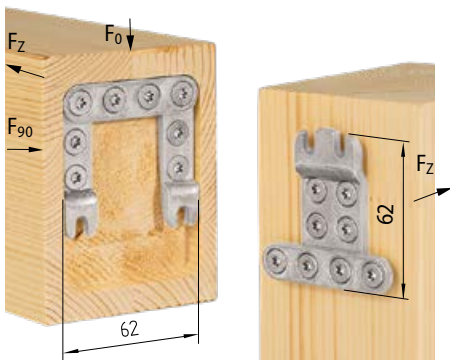

Mounting screws	5x40	5x60	Load capacity		
			zul F ₀	zul F ₉₀	zul F _Z
CS - FT	8	8	Slide-in direction	Right angle to slide-in direction	Traction
			2.53 kN	1.80 kN	2.33 kN

Recommended timber dimension	Size of rebate		
	Width	Height	Depth
Width/Height: 80/100 mm	62 mm	82 mm	8.5 mm

ACRO 90/62

Art.-No. K034

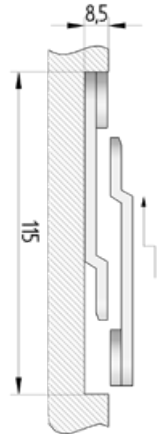
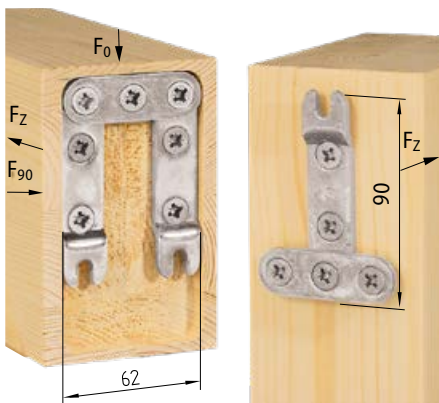

Mounting screws	6x40	6x60	Load capacity		
			zul F ₀	zul F ₉₀	zul F _Z
CS - FT	5	7	Slide-in direction	Right angle to slide-in direction	Traction
			4.49 kN	1.81 kN	2.60 kN

Recommended timber dimension	Size of rebate		
	Width	Height	Depth
Width/Height: 80/135 mm	62 mm	115 mm	8.5 mm

ACRO Serie 90

ACRO 90/90

Art.-No. K032

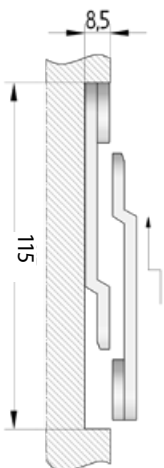
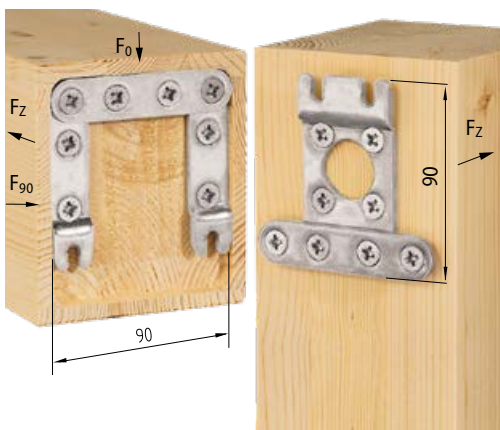

Mounting screws	6x40	6x60	Load capacity		
			zul F ₀	zul F ₉₀	zul F _Z
CS - FT	8	8	Slide-in direction	Right angle to slide-in direction	Traction
			5.40 kN	2.80 kN	2.39 kN

Recommended timber dimension	Size of rebate		
	Width	Height	Depth
Width/Height: 115/135 mm	90 mm	115 mm	8.5 mm

The load value refers to the shear force in the insertion direction. Commercially available, CS screws (5x40, 5x60, 6x40, 6x60 mm) in accordance with ÖNORM M 5027 must be used with the ACRO system. The test was carried out by Holzforschung Austria.

Installation



Route mortise with plunge router and routing jig.



Install ACRO connector brackets with screws



Assemble



Steps on central stringer fixed with Acro



ACRO

BASIS-System

Column/Post mounting connectors

Applications:	For direct mounting columns and posts on solid surfaces.
Advantages:	Quick-fit, heavy-duty push-in connector.
Suitable materials:	Timber post to firm ground i.e. concrete slab, tiles, stone, wood etc.
Installation:	With a portable router, bit mortiser or CNC machine.
Mounting:	One part of the BASIS System is pre-assembled on a galvanised steel plate and the whole unit is fixed to the ground. The second part is screwed to the end of the post and then fitted onto the plate.
Accessories:	For 62/62 : Routing-jig MULTI F62 Art.-No. K504, 2 Flute Straight Router Bit Art.-No. Z066, CS-screws 5x60 mm Art.-No. Z498 For 90/90 : Routing-jig MULTI F90 Art.-No. K505, 2 Flute Straight Router Bit Art.-No. Z066, CS-screws 6x60 mm Art.-No. Z499



Bowbridge



BASIS 62/62

Art.-No. K039

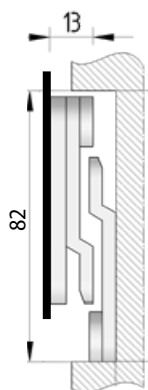
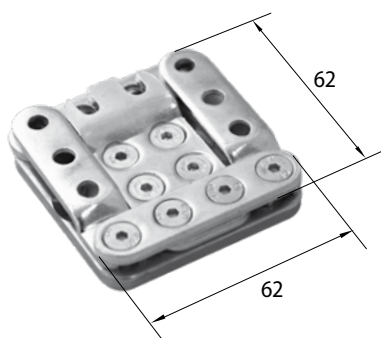

Mounting screws	5x60	M8	Load capacity		
			zul F ₀	zul F ₉₀	zul F _Z
CS - FT	8	2	Slide-in direction	Right angle to slide-in direction	Traction
			2.90 kN	2.47 kN	3.67 kN
Recommended timber dimension			Size of rebate		
Width/Height: 78/95 mm			Width	Height	Depth
			62 mm	82 mm	13 mm

BASIS 90/90

Art.-No. K038

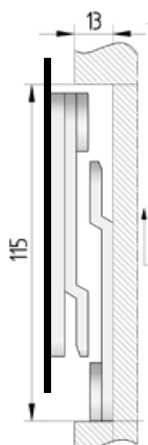
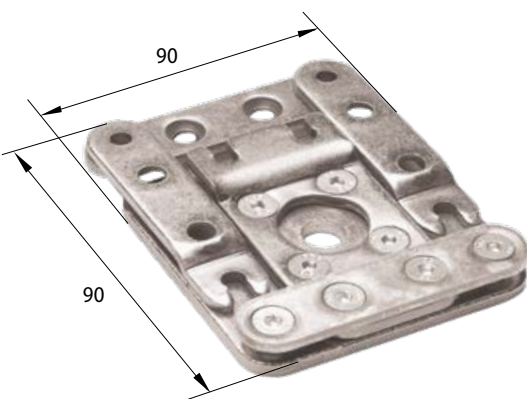

Mounting screws	5x60	M12	Load capacity		
			zul F ₀	zul F ₉₀	zul F _Z
CS - FT	8	1	Slide-in direction	Right angle to slide-in direction	Traction
			3.99 kN	2.07 kN	4.72 kN
Recommended timber dimension			Size of rebate		
Width/Height: 115/135 mm			Width	Height	Depth
			90 mm	115 mm	13 mm

The load value refers to the shear force in the insertion direction. Commercially available, CS screws (5x40, 5x60 mm) in accordance with ÖNORM M 5027 and M8 CS screws or M12 screws must be used with the BASIS system. The test was carried out by Holzforschung Austria

Post and beam connectors

Post and beam connectors

Beam connectors and
secondary beams connectors

Connectors for outdoor use

Curtain wall connectors



RICON® inox



Connectors inox A2 for sPHuctures bois en extérieur, jusqu'à 17,4 kN

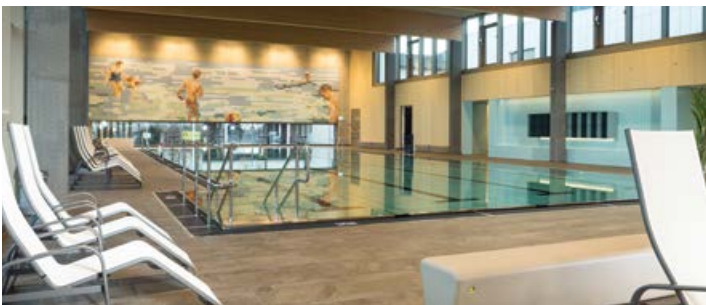

Applications:	Indoor and outdoor: furniture, balcony, deck, carport, playground and sports equipment, pergola, and light timber construction for usage classification 3.
Advantages:	Can be mounted visibly or invisibly, indoors or outdoors. Secure assembly with locking pin.
Suitable materials:	All wood species, such as oak, douglas fir, larch and impregnated woods, such as Accoya.
Technical details:	Used with narrow timber widths starting from 20 mm upwards. High strength capacity up to 17.4 kN, made of A2 stainless steel for usage classification 1, 2 ou 3.
Installation:	Quick and easy with a machining centre, router or portable router and the KNAPP® routing-jig.
Mounting:	Install plates with CS-screws Ø 5 mm and Ø 8 mm.
Accessories:	2 Flute Straight Router Bit Art.-No. Z066, routing-jig Multi F30 Art.-No. K501 and K506, mounting set RICON® Art.-No. K065



RICON INOX

RICON® inox 66/16

(Dimensions in mm)

RICON® 66/16 inox - single connection (EA)

Art.-No. K267

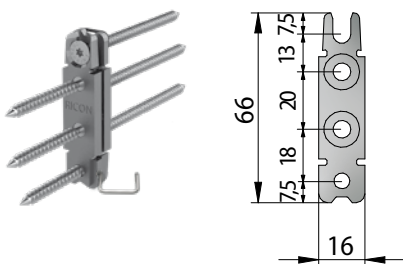

Connector	Connection	Screw connection		Charact. charge. [GL24h] C.SER.1*	
		Joist	Header	F _{1,RK} [kN]	F _{2,RK} [kN]**
66/16	EA	3 CS 5x80	3 CS 5x50	3.5	4.8
			1 locking clip: F _{3,RK} = 1,0 kN		2 locking clips: F _{3,RK} = 2,0 kN

Minimum timber cross section: 30 x 86 mm

Alternative screws: **load varies.

3 CS-screws 5x25

3 CS-screws 5x30

3 CS-screws 5x50

3 CS-screws 5x60

* Homogeneous glulam - indoor

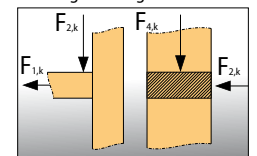

RICON® inox 70/20

(Dimensions in mm)

RICON® 70/20 inox - single connection (EA)

Art.-No. K271

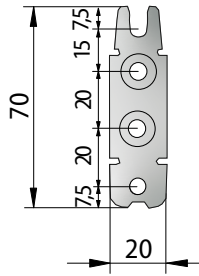

Connector	Connection	Screw connection		Charact. charge. [GL24h] C.SER.1*	
		Joist	Header	F _{1,RK} [kN]	F _{2,RK} [kN]**
70/20	EA	3 CS 5x80	3 CS 5x50	3.5	4.8
1 locking clip: F _{3,RK} = 1,0 kN			2 locking clips: F _{3,RK} = 2,0 kN		
Minimum timber cross section: 30 x 90 mm					
Alternative screws: **load varies.					
3 CS-screws 5x25		3 CS-screws 5x30			
3 CS-screws 5x50		3 CS-screws 5x60			

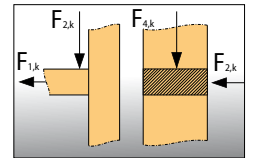

RICON® inox series 25

Minimum timber cross section

Inserted in the beam and screwed

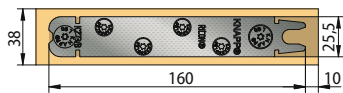

Built-in depth: 11 - 11,5 mm

Screwed onto post

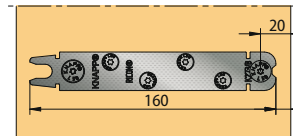

Minimum timber thickness: 50 mm

Inserted in the main beam and screwed

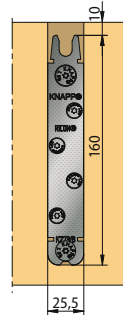

Minimum timber thickness: 60 mm

Screwed into the secondary beam

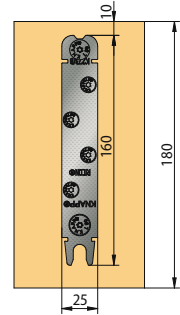

RICON® inox series 25

RICON® 120/25 inox - single connection (EA)

Art.-No. K272

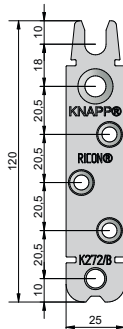

Connector	Connection	Screw connection		Charact. charge. [GL24h] C.SER.1*	
		Joist	Header	F _{1,RK} [kN]	F _{2,RK} [kN]
120/25	EA	2 CS 8x80 3 CS 5x80	2 CS 8x50 3 CS 5x50	4.4	8.9
1 locking clip: F _{3,RK} = 1,0 kN			2 locking clips: F _{3,RK} = 2,0 kN		
Minimum timber cross section: 38 x 140 mm					
* Homogeneous glulam - indoor					

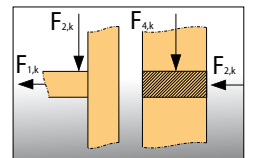

RICON® 160/25 inox - single connection (EA)

Art.-No. K273

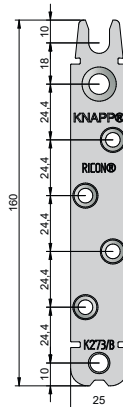

Connector	Connection	Screw connection		Charact. charge. [GL24h] C.SER.1*	
		Joist	Header	F _{1,RK} [kN]	F _{2,RK} [kN]
160/25	EA	2 CS 8x80 4 CS 5x80	2 CS 8x50 4 CS 5x50	4.4	10.4
1 locking clip: F _{3,RK} = 1,0 kN			2 locking clips: F _{3,RK} = 2,0 kN		
Minimum timber cross section: 38 x 180 mm					
* Homogeneous glulam - indoor					

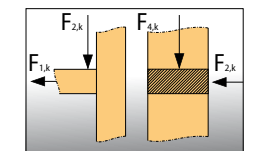

RICON® inox series 30

(Dimensions in mm)

Minimum timber cross section

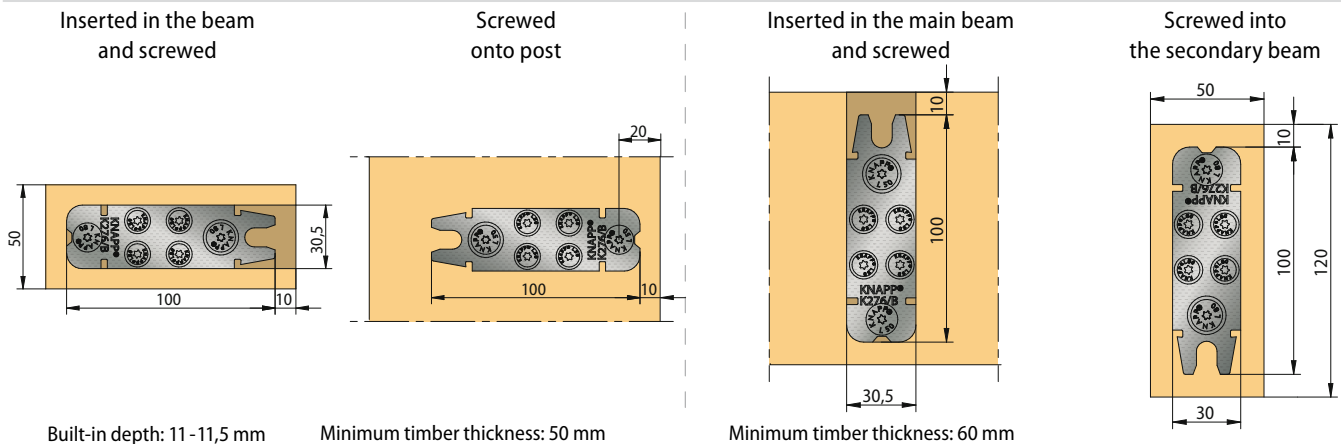

Built-in depth: 11 - 11,5 mm

Minimum timber thickness: 50 mm

Minimum timber thickness: 60 mm

RICON® inox series 30

RICON® 60/30 inox - single connection (EA)

Art.-No. K274

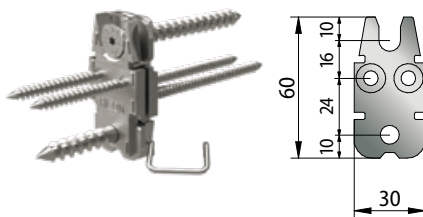

Connector	Connection	Screw connection		Charact. charge. [GL24h] C.SER.1*	
		Joist	Header	F _{1,RK} [kN]	F _{2,RK} [kN]
60/30	EA	2 CS 5x80 1 CS 8x80	2 CS 5x50 1 CS 8x50	4.4	5.2
1 locking clip: F _{3,RK} = 1.9 kN			2 locking clips: F _{3,RK} = 3.8 kN		

Minimum timber cross section: 50 x 80 mm

* Homogeneous glulam - indoor

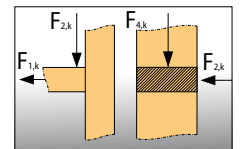

RICON® 80/30 inox - single connection (EA)

Art.-No. K275

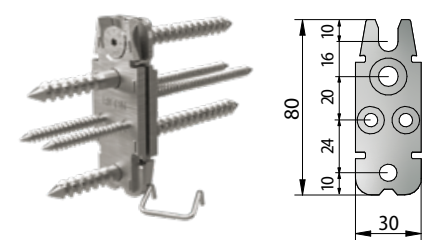

Connector	Connection	Screw connection		Charact. charge. [GL24h] C.SER.1*	
		Joist	Header	F _{1,RK} [kN]	F _{2,RK} [kN]
80/30	EA	2 CS 8x80 2 CS 5x80	2 CS 8x50 2 CS 5x50	4.4	7.5
1 locking clip: F _{3,RK} = 1.9 kN			2 locking clips: F _{3,RK} = 3.8 kN		

Minimum timber cross section: 50 x 100 mm

* Homogeneous glulam - indoor

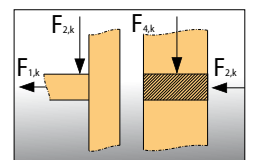

RICON® 100/30 inox - single connection (EA)

Art.-No. K276

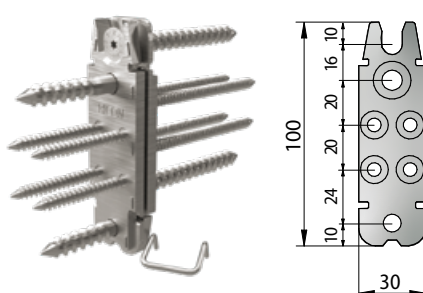

Connector	Connection	Screw connection		Charact. charge. [GL24h] C.SER.1*	
		Joist	Header	F _{1,RK} [kN]	F _{2,RK} [kN]
100/30	EA	2 CS 8x80 4 CS 5x80	2 CS 8x50 4 CS 5x50	4.4	10.4
1 locking clip: F _{3,RK} = 1.9 kN			2 locking clips: F _{3,RK} = 3.8 kN		

Minimum timber cross section: 50 x 120 mm

* Homogeneous glulam - indoor

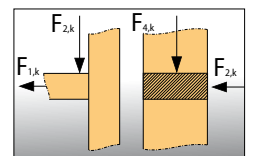

RICON® 120/30 inox - single connection (EA)

Art.-No. K277

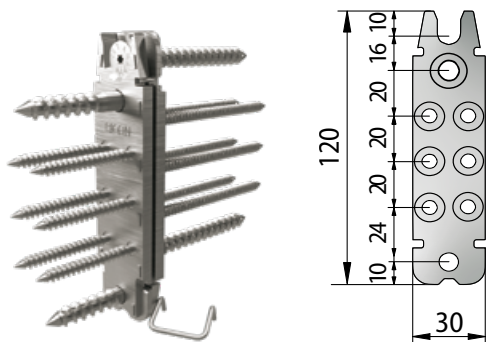

Connector	Connection	Screw connection		Charact. charge. [GL24h] C.SER.1*	
		Joist	Header	F _{1,RK} [kN]	F _{2,RK} [kN]
120/30	EA	2 CS 8x80 6 CS 5x80	2 CS 8x50 6 CS 5x50	4.4	13.2
1 locking clip: F _{3,Rk} = 1.9 kN			2 locking clips: F _{3,Rk} = 3.8 kN		

Minimum timber cross section: 50 x 140 mm

* Homogeneous glulam - indoor

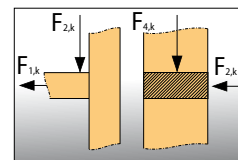

RICON® 140/30 inox - single connection (EA)

Art.-No. K278

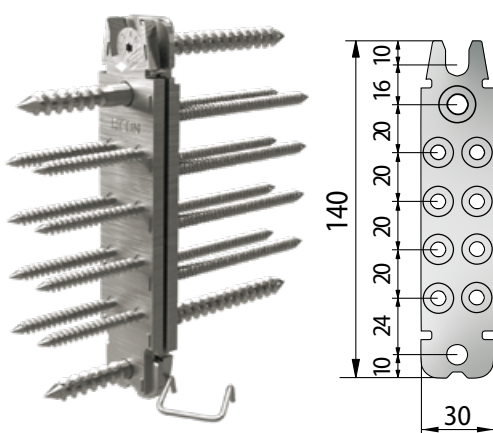

Connector	Connection	Screw connection		Charact. charge. [GL24h] C.SER.1*	
		Joint	Header	F _{1,RK} [kN]	F _{2,RK} [kN]
140/30	EA	2 CS 8x80 8 CS 5x80	2 CS 8x50 8 CS 5x50	4.4	16.1
1 locking clip: F _{3,Rk} = 1.9 kN			2 locking clips: F _{3,Rk} = 3.8 kN		

Minimum timber cross section: 50 x 160 mm

* Homogeneous glulam - indoor

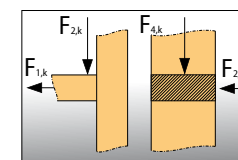

RICON® 160/30 inox - single connection (EA)

Art.-No. K279

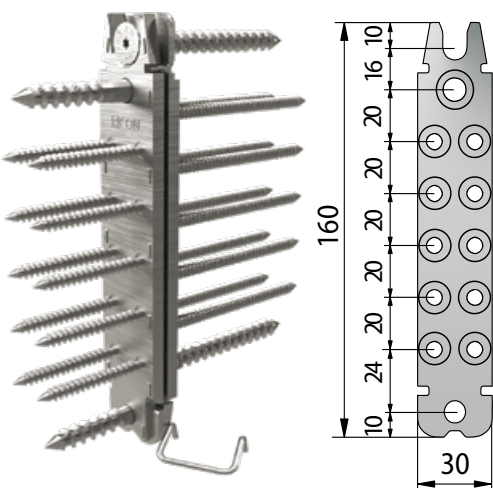

Connector	Connection	Screw connection		Charact. charge. [GL24h] C.SER.1*	
		Joist	Header	F _{1,RK} [kN]	F _{2,RK} [kN]
160/30	EA	2 CS 8x80 10 CS 5x80	2 CS 8x50 10 CS 5x50	4.4	17.4
1 locking clip: F _{3,Rk} = 1.9 kN			2 locking clips: F _{3,Rk} = 3.8 kN		

Minimum timber cross section: 50 x 180 mm

* Homogeneous glulam - indoor

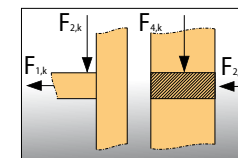

Installing RICON® inox - Main-secondary beam connection type



Mill with with routing-jig



Pre-drill and screw



Install locking clip



Assemble



Secured connection using a locking clip

RICON® inox series 40

(Dimensions in mm)

Minimum timber cross section

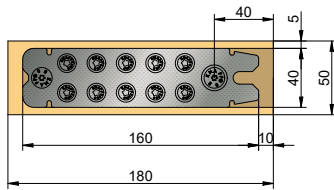
Inserted in the beam
and screwed

Built-in depth: 11 - 11,5 mm

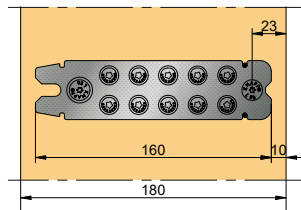
Screwed
onto post

Minimum timber thickness: 50 mm

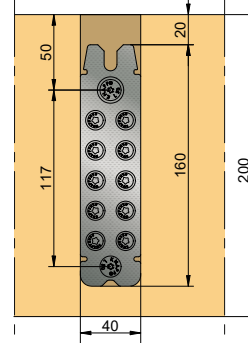
Inserted in the main beam
and screwed

Minimum timber thickness: 60 mm

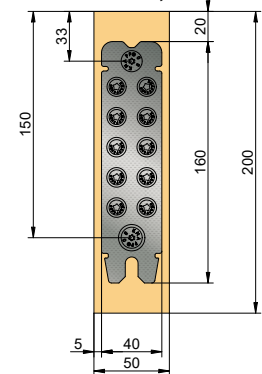
Screwed into
the secondary beam

RICON® inox series 40

RICON® 40/40 inox - single connection (EA)

Art.-No. K378

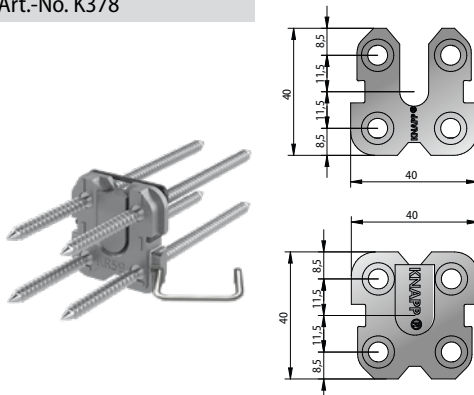

Connector	Connection	Screw connection		Charact. charge. [GL24h] C.SER.1*	
		Joist	Header	F _{1,Rk} [kN]	F _{2,Rk} [kN]
40/40	EA	4 CS 5x80	4 CS 5x50	7.5	4.0
1 locking clip: F _{3,Rk} = 2.7 kN			2 locking clips: F _{3,Rk} = 5.4 kN		

Minimum timber cross section: 50 x 60 mm

* Homogeneous glulam - indoor

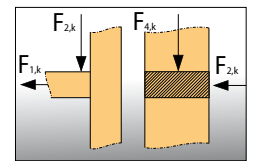

RICON® 80/40 inox - single connection (EA)

Art.-No. K372

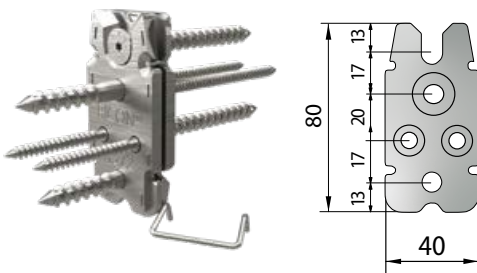

Connector	Connection	Screw connection		Charact. charge. [GL24h] C.SER.1*	
		Joist	Header	F _{1,Rk} [kN]	F _{2,Rk} [kN]
80/40	EA	2 CS 8x80 2 CS 5x80	2 CS 8x50 2 CS 5x50	4.4	7.5
1 locking clip: F _{3,Rk} = 2.7 kN			2 locking clips: F _{3,Rk} = 5.4 kN		

Minimum timber cross section: 50 x 100 mm

* Homogeneous glulam - indoor

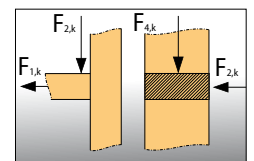

RICON® 160/40 inox - single connection (EA)

Art.-No. K376

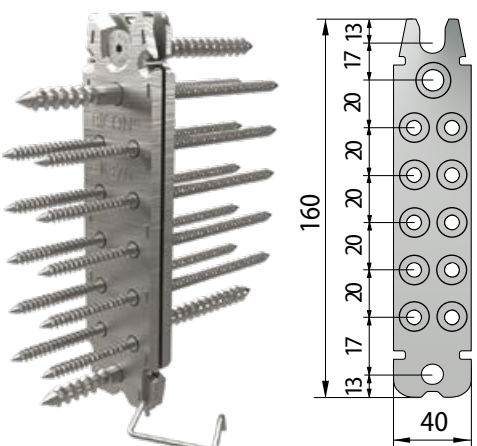

Connector	Connection	Screw connection		Charact. charge. [GL24h] C.SER.1*	
		Joist	Header	F _{1,Rk} [kN]	F _{2,Rk} [kN]
160/40	EA	2 CS 8x80 10 CS 5x80	2 CS 8x50 10 CS 5x50	4.4	17.4
1 locking clip: F _{3,Rk} = 2.7 kN			2 locking clips: F _{3,Rk} = 5.4 kN		

Minimum timber cross section: 50 x 180 mm

* Homogeneous glulam - indoor

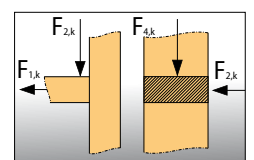

RICON® inox DA and EAR for all sizes

Double connection with connecting nuts and RICON® inox CS-screws (available upon request)

Single or double connection with inserts and RICON® inox CS-screws (available upon request)

DA

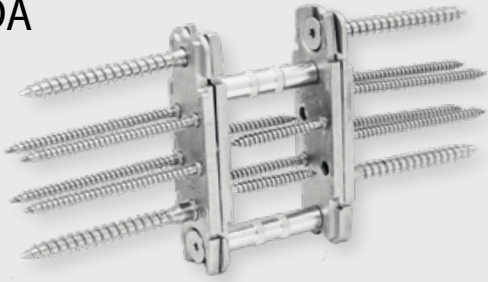

EAR



RICON DA



RICON EAR

RICON® inox screws

RICON® Self-tapping CS-screws with reinforced shaft

(delivery includes CS-screws with the matching RICON® connectors)

Art.-No. Z950 Inox A2 CS-screws 5x50

Art.-No. Z953 Inox A2 CS-screws 8x50



Application: to screw the RICON® inox plate into the side grain of main beam/post.

Art.-No. Z952 Inox A2 CS-screws 5x80

Art.-No. Z954 Inox A2 CS-screws 8x80



Application: to screw the RICON® inox plate into the side grain of secondary beam/latch.

RICON® inox DA - EAR CS-screws

Art.-No. Z955 Inox A2 CS-screws M5x16 (for RICON® 60/40 DA)

Art.-No. Z956 Inox A2 CS-screws M8x18 (for RICON® DA and EAR)



Application: to mount RICON® plate in a cross joint double connector (DA or EAR).

RICON® DA connecting nuts

(delivery includes connecting nuts with the matching RICON® connectors)

Art.-No. K540 Connecting nut M5 8x48 50 mm post thickness

Art.-No. K541 Connecting nut M5 8x53 55 mm post thickness

Art.-No. K542 Connecting nut M5 8x58 60 mm post thickness

Art.-No. K543 Connecting nut M5 8x78 80 mm post thickness



Application: to mount RICON® inox 60/40 double connector (DA).

Art.-No. K544 Connecting nut M8 10x36 <50 mm post thickness

Art.-No. K545 Connecting nut M8 10x48 50 mm post thickness

Art.-No. K546 Connecting nut M8 10x53 55 mm post thickness

Art.-No. K547 Connecting nut M8 10x58 60 mm post thickness

Art.-No. K548 Connecting nut M8 10x68 70 mm post thickness

Art.-No. K549 Connecting nut M8 10x78 80 mm post thickness



Application: to mount RICON® and RICON® inox bigger sizes double connectors (DA).

Insert RICON® inox EAR

(delivery for connecting nuts with the matching RICON® connectors are available upon request)

Art.-No. Z540 Insert M5x14 for RICON® 60/40

Art.-No. Z541 Insert M8x18

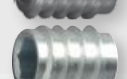

Application: to mount unique applications and post sizes.

RICON®

Post and beam connectors, main and secondary beams, curtain walls

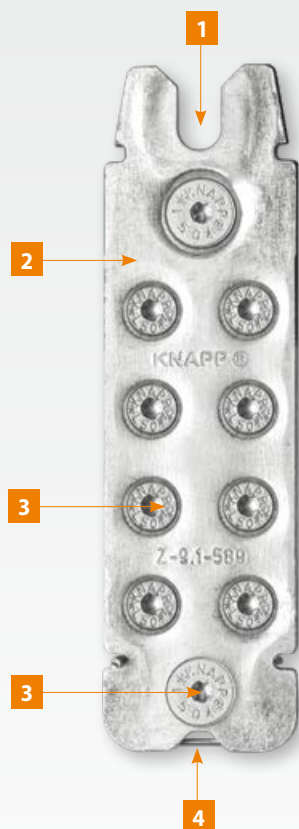

1 The dovetail shape ensures optimum reception of the RICON® retaining CS-screws. The short clamping distance makes it easy to hook in, while engaging the plates, ensuring tightness and fast assembly of the elements.

2 RICON® consists of two identical parts. It is made in Austria from a premium quality steel and is also available hot-dip galvanized.

3 Ø 5 mm and Ø 8 mm RICON® CS-screws. These adjustable holding screws compensate fabrication tolerances. The reinforced shaft with integrated stop guarantees exact positioning.

4 The stainless spring steel locking clip can be installed into the locating slots prior to final assembly. It locks the connection against the slide-indirection and can be released again.

Fire rating: Fire resistance (EN 1995-1-2) through 3-4 sided concealed, joint-tight installation (R30 ≥ 28 mm, R60 ≥ 49 mm)

AUSTRIA



RICON



Applications:	Aluminium timber curtain walls, conservatories, overhanging roofs, roof structures.
Advantages:	Invisible connection, assembly of curtain wall rails, from the inside or outside, secure connections with automatic locking pins, removable.
Suitable materials:	Solid wood and wood materials, softwood or hardwood, LVL, BauBuche, steel and concrete.
Technical details:	For timber sections from 50 mm thick, up to 700 kg load capacity for curtain walls and 23 kN load capacity for main and secondary beam connections.
Installation:	Simple and fast with a machining centre, router or portable router and the KNAPP® routing-jig.
Mounting:	Install plates with CS-screws Ø 5 mm and Ø 8 mm.
Accessories:	2 Flute Straight Router Bit Art.-No. Z066, routing-jig Multi F30 Art.-No. K501 and K506, mounting set RICON® Art.-No. K065.

RICON®

Application examples and connection details

Wood curtain wall up to 700 kg

(Dimensions in mm)

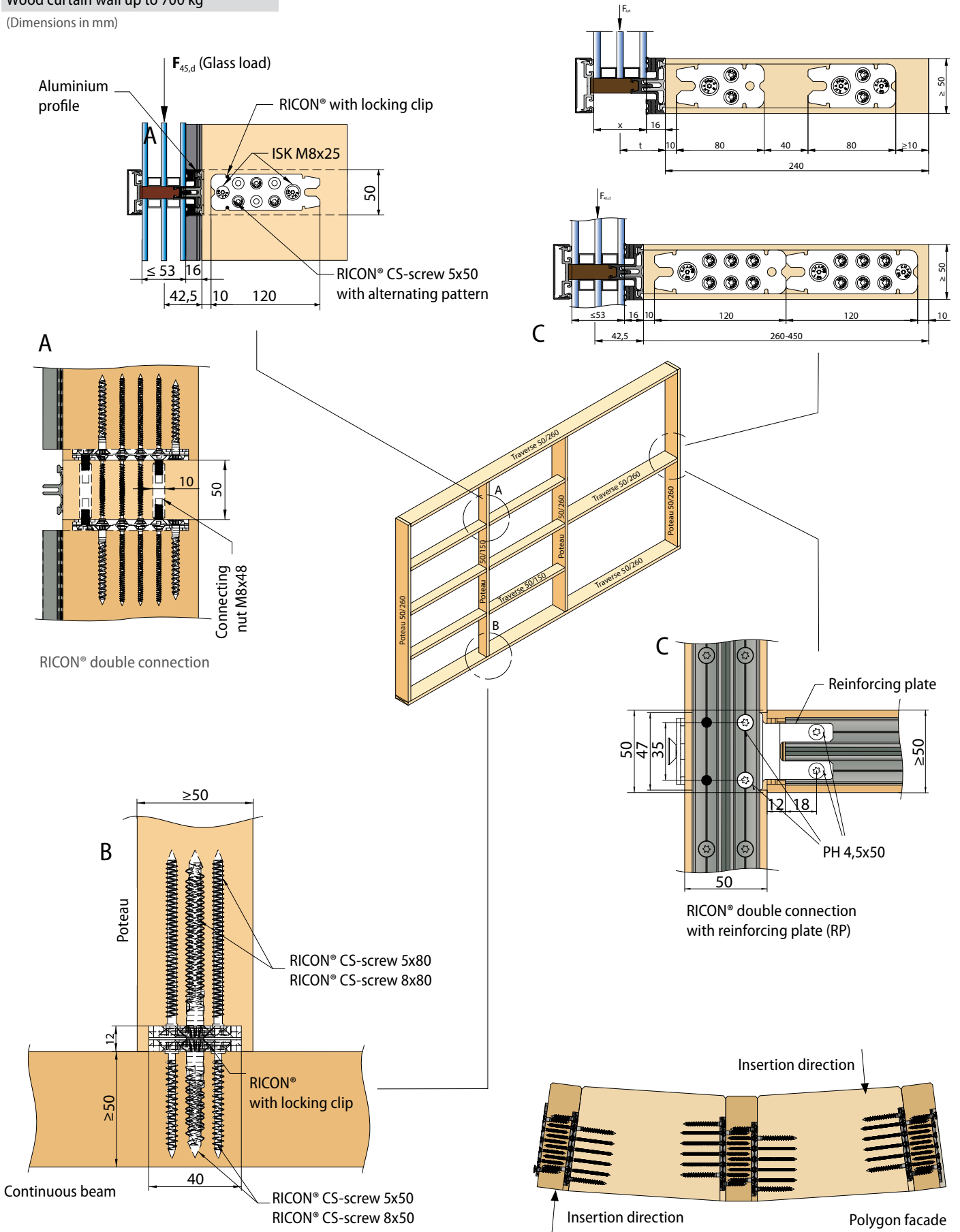

RICON®

Exemples d'applications and détails d'assemblages

Main-secondary beam connections
e.g. wood beam ceilings, roofs and sunrooms.

Wood to steel
connection

Wood to concrete connection
e.g. with RICON® 140/40

(Dimensions in mm)

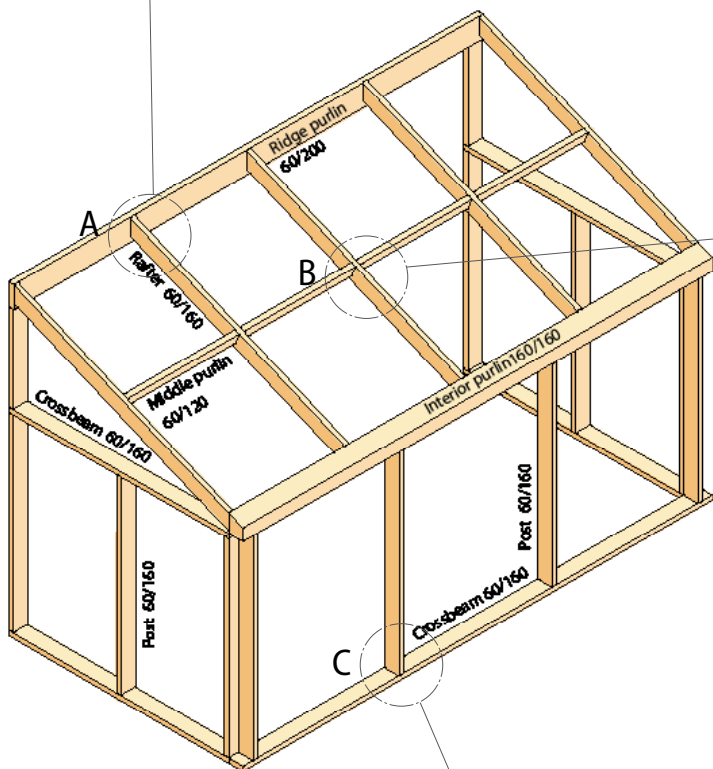
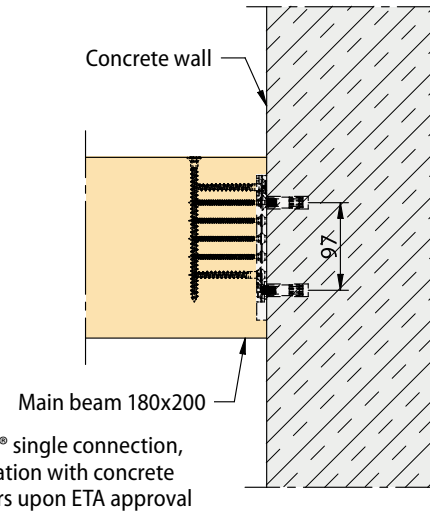
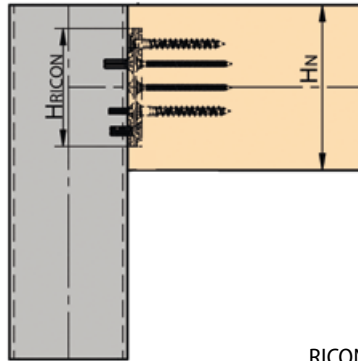
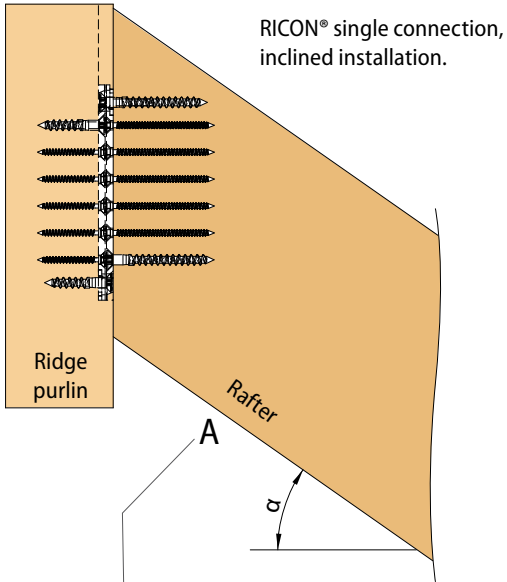

RICON®
double
connection

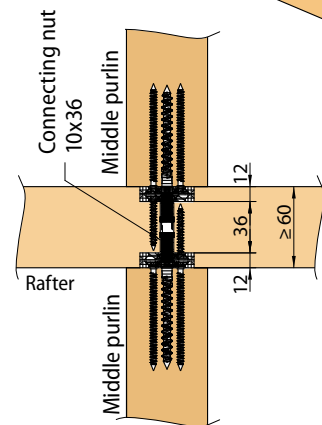
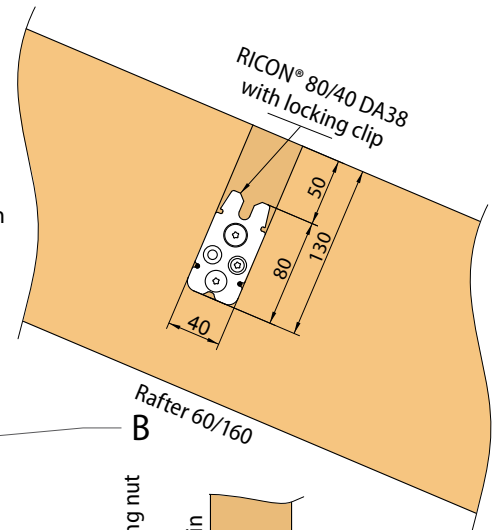

RICON®
single connection

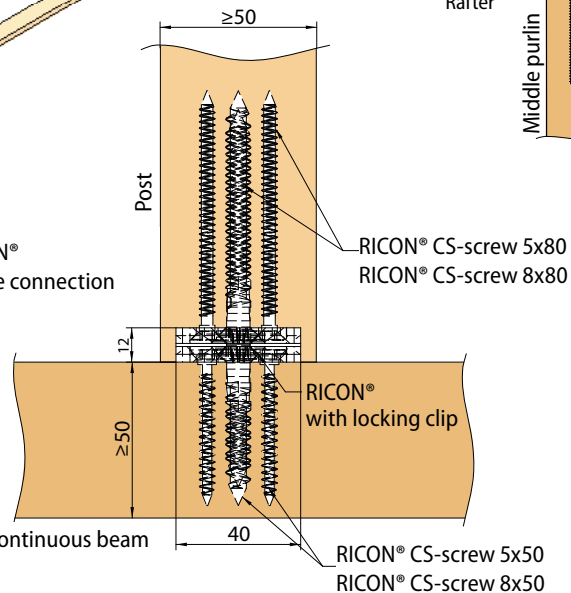

© Solarlux

Construction of a sunroom.

RICON® 60/40

(Dimensions in mm)

Minimum timber cross section

Inserted in the beam and screwed

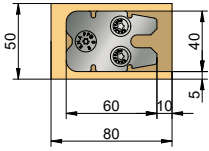

Built-in depth: 12 - 12.5 mm

Screwed onto post

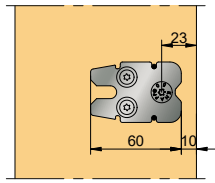

Min. width of beam and post: 50 mm

Inserted in the main beam and screwed

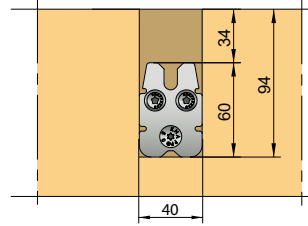

Min. width of of main beam: 60 mm

Screwed into the secondary beam

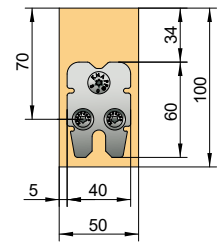

RICON® 60/40 EA - single connection

Art.-No. K360

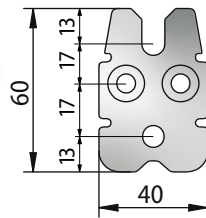

Connector	Connection	Screw connection		Charact. charge. [GL24h] C.SER.1*	
		Joist	Header	F _{1,Rk} [kN]	F _{2,Rk} [kN]
60/40	EA	2 CS 5x80 1 CS 8x80	2 CS 5x50 1 CS 8x50	4.4	5.0
1 locking clip: F _{3,Rk} = 2.7 kN			2 locking clips: F _{3,Rk} = 5.15 kN		

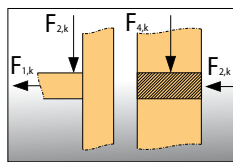

Minimum timber dimensions: 50 x 80 mm

Single connection for post and beam connection with a minimum timber cross section of 50 mm (stress at mid to the axis of beam)

* alternatively, longer screws can be used in end grain.

1 CS-screw 8x160 - F_{2,Rk} = 6.3 kN

RICON® 80/40

Minimum timber cross section

Inserted in the beam and screwed

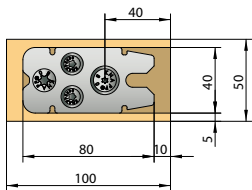

Built-in depth: 12 - 12.5 mm

Screwed onto post

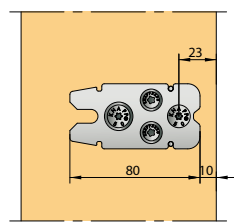

Min. width of beam and post: 50 mm

Inserted in the main beam and screwed

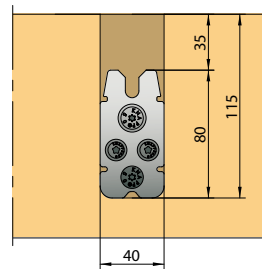

Min. width of of main beam: 60 mm

Screwed into the secondary beam

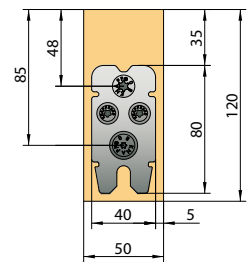

RICON® 80/40 EA - single connection

Art.-No. K361

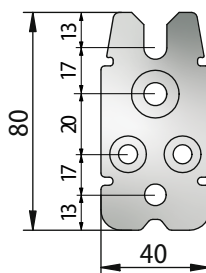

Connector	Connection	Screw connection		Charact. charge. [GL24h] C.SER.1*	
		Joist	Header	F _{1,Rk} [kN]	F _{2,Rk} [kN]
80/40	EA	2 CS 5x80 2 CS 8x80	2 CS 5x50 2 CS 8x50	4.4	7.3
1 locking clip: F _{3,Rk} = 2.7 kN			2 locking clips: F _{3,Rk} = 5.4 kN		

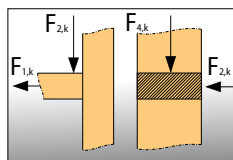

Minimum timber dimensions: 50 x 100 mm

Single connection for post and beam connection with a minimum timber cross section of 50 mm (stress at mid to the axis of beam)

* alternatively, longer screws can be used in end grain.

2 CS-screws 8x160 - F_{2,Rk} = 10.3 kN

RICON® 100/40

(Dimensions in mm)

Minimum timber cross section

Inserted in the beam and screwed

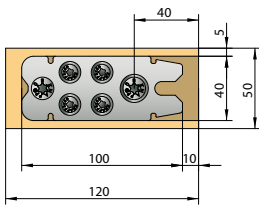

Built-in depth: 12-12.5 mm

Screwed onto post

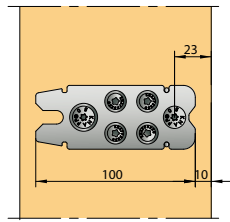

Min. width of beam and post: 50 mm

Inserted in the main beam and screwed

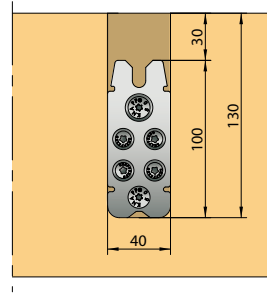

Min. width of of main beam: 60 mm

Screwed into the secondary beam

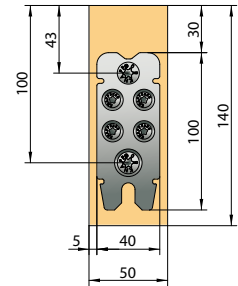

RICON® 100/40 EA - single connection

Art.-No. K362

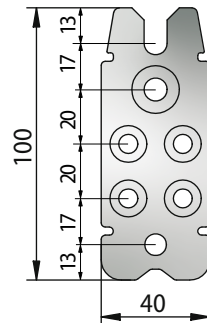

Connector	Connection	Screw connection		Charact. charge. [GL24h] C.SER.1*	
		Joist	Header	F _{1,RK} [kN]	F _{2,RK} [kN]
100/40	EA	4 CS 5x80 2 CS 8x80	4 CS 5x50 2 CS 8x50	4.4	10.0
1 locking clip: F _{3,RK} = 2.7 kN			2 locking clips: F _{3,RK} = 5.4 kN		

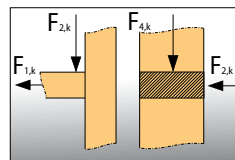

Minimum timber dimensions: 50 x 120 mm

Single connection for post and beam connection with a minimum timber cross section of 50 mm (stress at mid to the axis of beam)

* alternatively, longer screws can be used in end grain.

2 CS-screws 8x160 - F_{2,RK} = 13.9 kN

RICON® 120/40

Minimum timber cross section

Inserted in the beam and screwed

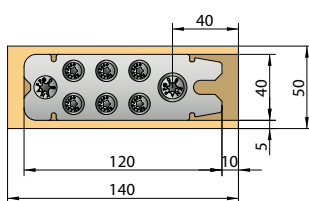

Built-in depth: 12-12.5 mm

Screwed onto post

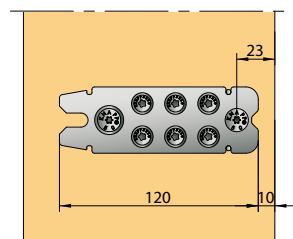

Min. width of beam and post: 50 mm

Inserted in the main beam and screwed

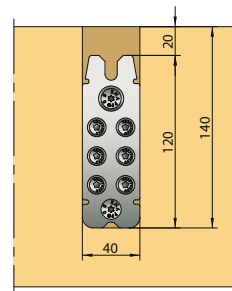

Min. width of of main beam: 60 mm

Screwed into the secondary beam

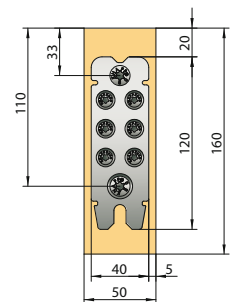

RICON® 120/40 EA - single connection

Art.-No. K363

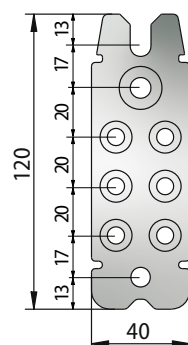

Connector	Connection	Screw connection		Charact. charge. [GL24h] C.SER.1*	
		Joist	Header	F _{1,RK} [kN]	F _{2,RK} [kN]
120/40	EA	6 CS 5x80 2 CS 8x80	6 CS 5x50 2 CS 8x50	4.4	12.8
1 locking clip: F _{3,RK} = 2.7 kN			2 locking clips: F _{3,RK} = 5.4 kN		

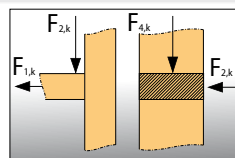

Minimum timber dimensions: 50 x 140 mm

Single connection for post and beam connection with a minimum timber cross section of 50 mm (stress at mid to the axis of beam)

* alternatively, longer screws can be used in end grain.

2 CS-screws 8x160 - F_{2,RK} = 16.6 kN

RICON® 140/40

(Dimensions in mm)

Minimum timber cross section

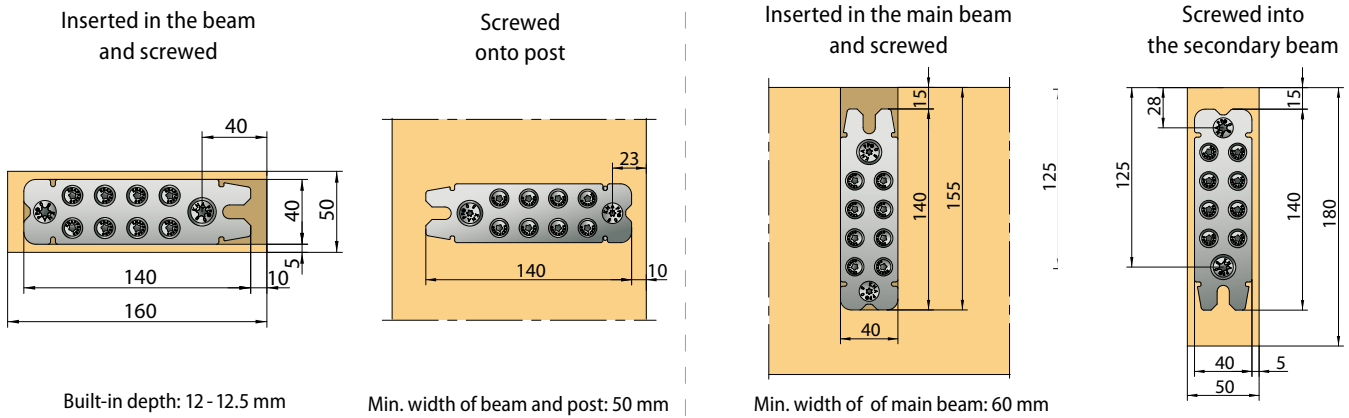

RICON® 140/40 EA - single connection

Art.-No. K365

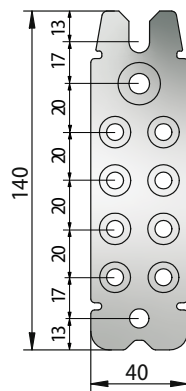

Connector	Connection	Screw connection		Charact. charge. [GL24h] C.SER.1*	
		Joist	Header	F _{1,Rk} [kN]	F _{2,Rk} [kN]
140/40	EA	8 CS 5x80 2 CS 8x80	8 CS 5x50 2 CS 8x50	4.4	15.5
		1 locking clip: F _{3,Rk} = 2,7 kN		2 locking clips: F _{3,Rk} = 5,4 kN	

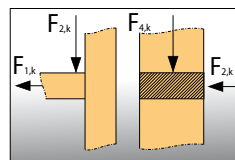

Minimum timber dimensions: 50 x 160 mm

Single connection for post and beam connection with a minimum timber cross section of 50 mm (stress at mid to the axis of beam)

* alternatively, longer screws can be used in end grain.
2 CS-screws 8x160 - F_{2,Rk} = 19,3 kN

RICON® 160/40

Minimum timber cross section

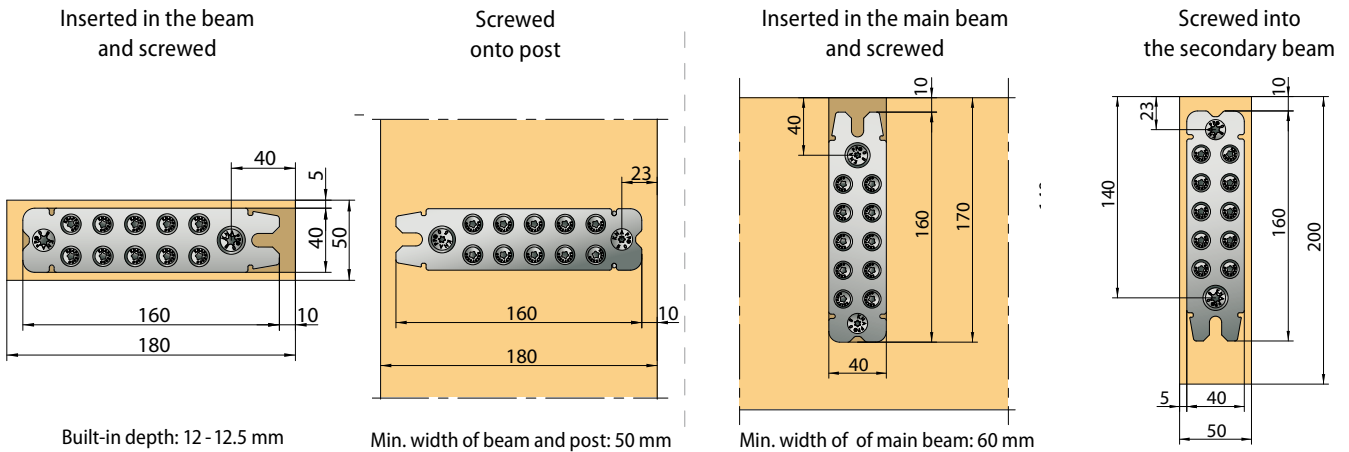

RICON® 160/40 EA - single connection

Art.-No. K364

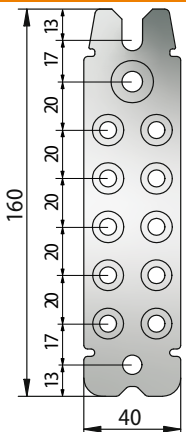

Connector	Connection	Screw connection		Charact. charge. [GL24h] C.SER.1*	
		Joist	Header	F _{1,Rk} [kN]	F _{2,Rk} [kN]
160/40	EA	10 CS 5x80 2 CS 8x80	10 CS 5x50 2 CS 8x50	4.4	18.2
		1 locking clip: F _{3,Rk} = 2.7 kN		2 locking clips: F _{3,Rk} = 5.4 kN	

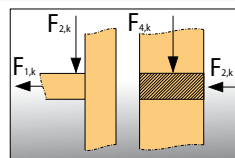

Minimum timber dimensions: 50 x 180 mm

Single connection for post and beam connection with a minimum timber cross section of 50 mm (stress at mid to the axis of beam)

* alternatively, longer screws can be used in end grain.
2 CS-screws 8x160 - F_{2,Rk} = 22.0 kN

RICON® DA and EAR for all sizes

Double connection with connecting nuts and RICON® CS-screws

DA

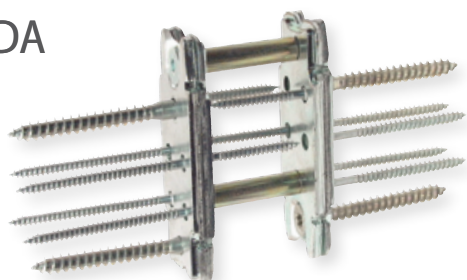

RICON DA

Single- or dual connection with insert and RICON® CS-screws

EAR



RICON EAR

RICON® screws

RICON® Self-tapping CS-screws with reinforced shaft

(CS-screws are included with all RICON® connectors)

Art.-No. Z533

CS-screws 5x50



Art.-No. Z531

CS-screws 8x50



Application: to mount RICON plate into the side grain of main beam/post.



Art.-No. Z534

CS-screws 5x80



Art.-No. Z532

CS-screws 8x80



Art.-No. Z581

CS-screws 8x160

Application: to mount RICON plate into the end grain of secondary beam.

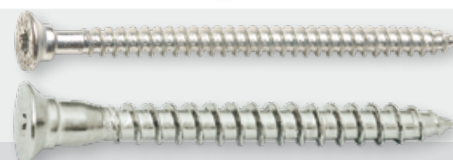

CS-screws (CS) RICON® DA

Art.-No. Z545

CS-screws RICON® M5x20 (for RICON® 60/40 DA)



Art.-No. Z548

CS-screws RICON® M8x25



Application: to mount RICON plate in a cross joint double connector application.

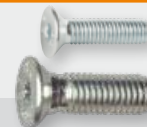

Connecting nuts RICON® DA

(Connecting nuts are included with all RICON DA connectors)

Art.-No. K540

Connecting nut M5 8x48

50 mm post thickness

Art.-No. K541

Connecting nut M5 8x53

55 mm post thickness

Art.-No. K542

Connecting nut M5 8x58

60 mm post thickness

Art.-No. K543

Connecting nut M5 8x78

80 mm post thickness



Application: to mount RICON® 60/40 double connector (DA).

Art.-No. K544

Connecting nut M8 10x36

<50 mm post thickness

Art.-No. K545

Connecting nut M8 10x48

50 mm post thickness

Art.-No. K546

Connecting nut M8 10x53

55 mm post thickness

Art.-No. K547

Connecting nut M8 10x58

60 mm post thickness

Art.-No. K548

Connecting nut M8 10x68

70 mm post thickness

Art.-No. K549

Connecting nut M8 10x78

80 mm post thickness



Application: to mount RICON 80/40 and bigger sizes double connectors.

Inserts RICON® EAR

(connecting inserts can be included upon request)

Art.-No. Z540

Insert M5x14 for RICON® 60/40

Art.-No. Z541

Insert M8x18



Application: for unique applications and post sizes.

RICON® accessories

Routing-jig for all RICON® sizes

Art.-No. K502 Routing-jig MULTI F40 (plywood)

Note: the routing-jig MULTI F is suitable for a Ø 30 mm bushing guide (for plunge router) and a Ø 15 mm TCT router cutter.

Application: for milling the pocket to recess connector for concealed mounting.



RICON® EA/DA drilling-jig guide (galvanized steel)

Art.-No.	K621	K622	K623	K624	K629	K630
	60/40	80/40	100/40	120/40	140/40	160/40

Application: for installation into the drilling-jig and exact pre-drilling of the positioning screws.



TCT slotting cutter

Art.-No. Z066 2 flute straight router bits Ø 15 mm, 25 mm length with Ø 8 mm shank

Application: to recess the rebate for RICON® and GIGANT.



RICON® locking clip (stainless spring steel)

Art.-No. K064 RICON® locking clip

Application: to lock the connectors against slide-in direction. If necessary, the connection can be released again.



RICON® EA/DA drilling-jig for post-beam connections

Art.-No.	K634	K635	K636	K637	K638	K639
	60/40 Set	80/40	100/40	120/40	140/40	160/40

RICON® EA/DA drilling-jig for header-joint connections

Art.-No.	K634	K642	K643	K644	K645	K646
	60/40 Set	80/40	100/40	120/40	140/40	160/40

Application: guide for pre-drilling holes of all RICON® connectors.



RICON® drilling-jig with adjustable drilling blocks

Art.-No.	-	K647	K647	K647	K647	K647
Drilling blocks:	-	80/40	100/40	120/40	140/40	160/40

Application: guide for pre-drilling holes of all RICON® connectors.

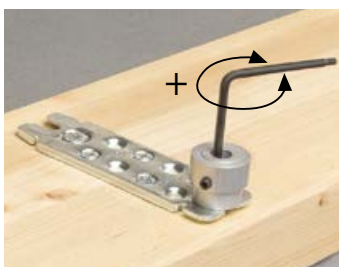

RICON® mounting set

Art.-No. K065 Consisting of: 1 RICON®-depth gauge incl. 1 Torx wrench T25 combined with Allen key SW5

Application: for fine tuning of RICON® CS-screws.



RICON®

Load bearing capacities for timber curtain wall example

(Dimensions in mm)

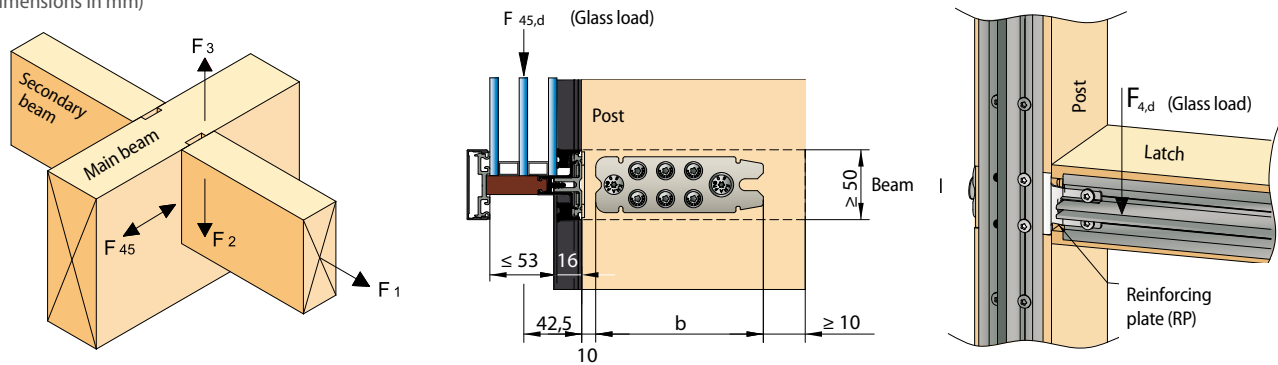

RICON®	Timber grade	Characteristic values			Charact. charge. [kN] $F_{3,Rk}$		Eccentric glass loads/post $F_{4,Rd}$	
		$F_{1,Rk}$ [kN]	$F_{2,Rk}$ [kN]	Centred $F_{45,Rk}$ [kN]	Locking clip(s)		without VP [kg]	with VP [kg]
					1	2		
60/40	C24	4,1	4,7	5,2	2,7	5,0	43	317
	GL24h	4,4	5,0	5,2			47	320
	GL32h	4,9	5,5	5,2			52	326
80/40	C24	4,1	6,8	8,0	2,7	5,4	59	332
	GL24h	4,4	7,3	8,7			64	337
	GL32h	4,9	8,1	9,7			71	345
100/40	C24	4,1	9,4	11,8	2,7	5,4	94	368
	GL24h	4,4	10,0	12,8			102	376
	GL32h	4,9	11,0	14,3			114	388
120/40	C24	4,1	12,0	15,4	2,7	5,4	131	404
	GL24h	4,4	12,8	15,6			142	415
	GL32h	4,9	14,0	15,6			158	432
140/40	C24	4,1	14,5	15,6	2,7	5,4	169	443
	GL24h	4,4	15,5	15,6			183	457
	GL32h	4,9	16,9	15,6			205	478
160/40	C24	4,1	17,1	15,6	2,7	5,4	210	484
	GL24h	4,4	18,2	15,6			227	501
	GL32h	4,9	19,9	15,6			254	528
2 x 80/40	C24	4,1	11,5	10,4	2,7	5,4	180	453
	GL24h	4,4	12,3	10,4			195	468
	GL32h	4,9	13,6	10,4			218	491
2 x 100/40	C24	4,1	16,6	15,6	2,7	5,4	270	543
	GL24h	4,4	17,8	15,6			292	566
	GL32h	4,9	19,5	15,6			327	600
2 x 120/40	C24	4,1	21,8	15,6	2,7	5,4	356	630
	GL24h	4,4	23,2	15,6			385	659
	GL32h	4,9	25,4	15,6			431	704

Tested at the University of Karlsruhe (KIT), **Building certification:** ETA-10/0189

Monitored by Univ.-Prof. Dr.-Ing. Blaß. at the University of Karlsruhe (KIT) Research Center for Steel, Timber and Masonry.

$F_{1,Rk}/F_{1,Rd}$ Characteristic/Design values of load-bearing capacity in the case of single stress perpendicular to the connector plate (tension)

$F_{2,Rk}/F_{2,Rd}$ Characteristic/Design values in slide-in direction

$F_{3,Rk}/F_{3,Rd}$ Characteristic/Design values against the slide-in direction

$F_{45,Rk}/F_{45,Rd}$ Characteristic/Design values perpendicular to slide-in direction

Glazing up to 1100 kg with the Schüco AOC.TI curtain wall profile system:

In combination with RICON® connectors for the assembly of the wooden supporting structure and with the help of suitable glazing supports, this system allows glazing loads of up to 1,100 kg per crossbar.

www.schueco.com

RICON® reinforcing plate (inox)**

K519	K523	K530	K531	K533	K534	K535	K536	K537	K538	K539
Schüco GP 50/50 50 mm*	Schüco GP 50/60 60 mm*	RP RP-tecline 50A0-HA 50mm*	RP RP-tecline 60A0-HA 60mm*	RP RP-tecline 80A0-HA 80mm*	Gutmann P GF 50 50 mm*	Gutmann P GF 60 60 mm*	Gutmann P GF 80 80 mm*	RAICO GP 41 and 47 50 mm*	RAICO GP 41 and 47 60 mm*	RAICO GP 67 80 mm*

Application: The reinforcing plate connects the base aluminium profiles and increases the load capacity of the post and beam connection. The reinforcing plate is available for different base profiles (see table). Reinforcing plates for other profiles on request.

*width of post and beam



** Reinforcing plates are approved by the building authorities for all common systems as shown in ETA-10/0189.

RICON® wood to concrete connection

Header-joist connection with glued anchor

(Dimensions in mm)

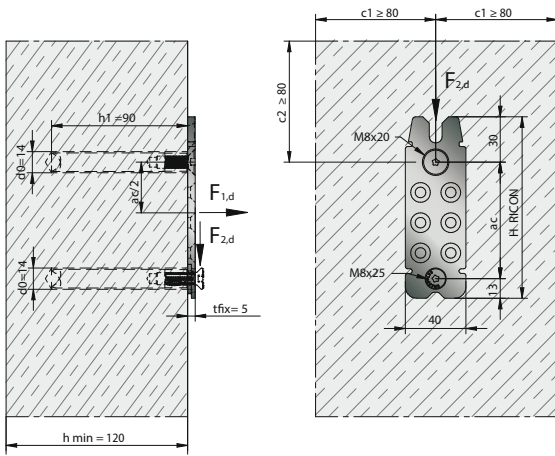

Concrete strength class C20/25

fischer RG 12x90 M18 I (8.8) with CS M8x25 and CS M8x20 (zinc-coated steel)

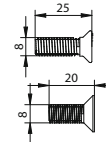
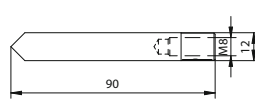

CS M8x25 with hexagon socket

CS M8x20 with hexagon socket

fischer Superbond-System: FIS SB 390 S

Drill hole diameter d_0	= 14 mm
Drill hole depth h_1	= 90 mm
Total fixing thickness C_{SIX}	= 5 mm
Spacing a_c	= cf. table
Minimal edge distance $c_{1,min} = c_{2,min}$	= 80 mm
Minimal concrete wall thickness h_{min}	= 120 mm
Approval:	ETA-12/0258



Wood to concrete connection in slide-in direction F_2

F_2 load-bearing values in the direction of insertion

KNAPP® connector	Concrete connection		Timber connection						
	$F_{2,Rd,béton}$	Spacing	Wood material		$F_{2,Rd,bois}$				
	Shear force $F_{2,Rd,béton}$ [kN]	Dowel spacing a_c [mm]	Wood type	Char. Density ρ_k [kg/m³]	Characteristic values [kN]		Design values $F_{2,Rd, Y_M = 1,3}$ [kN]		
					$F_{2,KCC,Rk}, Y_M = 1,0$	$F_{2,Rk}$	$k_{mod} = 0,6$	$k_{mod} = 0,8$	$k_{mod} = 0,9$
RICON® 100/40	14,00	57,00	C24	350	14,00	9,40	4,34	5,78	6,51
			GL24h	385					
RICON® 120/40	18,00	77,00	C24	350	18,00	12,00	5,54	7,38	8,31
			GL24h	385					
RICON® 140/40	18,00	97,00	C24	350	18,00	14,50	6,69	8,92	10,04
			GL24h	385					
RICON® 160/40	18,00	117,00	C24	350	18,00	17,10	7,89	10,52	11,84
			GL24h	385					

Service class: 1-2

$Y_{M,timber} = 1,3$

Calculation of $F_{2,Rd}$ for timber-concrete connection:

$$F_{2,Rk} = \min \left\{ \begin{array}{l} \min F_{2,Rd, timber} \\ \min F_{2,Rd, concrete} \end{array} \right. \quad F_{2,Rk, timber} = \min \left\{ \begin{array}{l} \min F_{2,KCC, Rk} / Y_M \\ \min F_{2,Rk} \cdot k_{mod} \\ Y_{M, timber} \end{array} \right.$$

Note:
The fischer anchors for KNAPP wood-to-concrete connections were determined according to the above tables and on the basis of a concrete class C20/25 with the fischer C-FIX calculation tool. They have been specially checked by fischer. Any cases outside the tables must be checked by KNAPP®, fischer or a competent engineer. In many cases, dimensioning with the C-FIX calculation tool is sufficient. The complete analysis of concrete fasteners is available on request from KNAPP®. KNAPP® accepts no liability for the incorrect use of the tables in this document. The condition of the concrete elements (strength classes and surfaces) must be checked by a professional, KNAPP® accepts no responsibility for this. KNAPP® products and KNAPP® connectors must be installed in accordance with the respective installation rules and instructions as well as the respective Technical Assessments.

Other anchoring solutions are possible, they must be technically suitable and have an ETA technical assessment.

Header-joint connection with heavy duty anchor

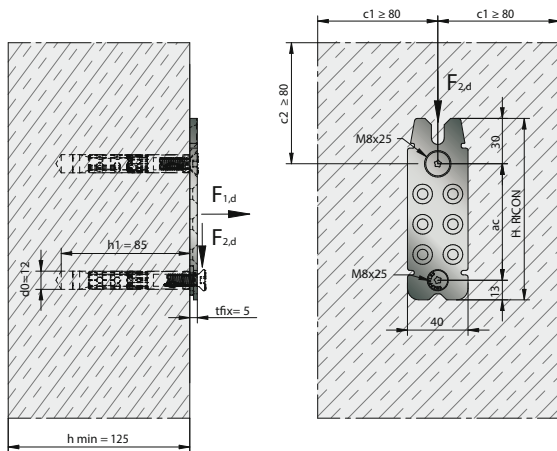

Concrete strength class C20/25

fischer FH II 12/M8 I (8.8) with CS M8x30 (zinc-coated steel)

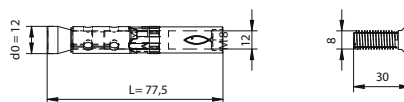

CS M8x30 with hexagon socket

Drill hole diameter d_0	= 12 mm
Drill hole depth h_1	= 85 mm
Total fixing thickness C_{fix}	= 5 mm
Spacing a_c	= cf. table
Minimal edge distance $c_{1,\text{min}} = c_{2,\text{min}}$	= 80 mm
Minimal concrete wall thickness h_{min}	= 125 mm
Approval:	ETA-07/0025, Option 1

Wood to concrete connection in slide-in direction F_2 F_2 load-bearing values in the direction of insertion

KNAPP® connector	Concrete connection		Timber connection						
	$F_{2,\text{Rd,concrete}}$	Spacing	Wood material		$F_{2,\text{Rd,timber}}$				
	Shear force $F_{2,\text{Rd,concrete}}$ [kN]	Dowel spacing a_c [mm]	Wood type	Char. Density ρ_k [kg/m ³]	Characteristic values [kN]		Design values $F_{2,\text{Rd}}, \gamma_M = 1,3$ [kN]		
					$F_{2,\text{KCC,Rk}}, \gamma_M = 1,0$	$F_{2,\text{Rk}}$	$k_{\text{mod}} = 0,6$	$k_{\text{mod}} = 0,8$	$k_{\text{mod}} = 0,9$
RICON® 100/40	14,00	57,00	C24	350	14,00	9,40	4,34	5,78	6,51
			GL24h	385		10,00	4,62	6,15	6,92
RICON® 120/40	16,00	77,00	C24	350		12,00	5,54	7,38	8,31
			GL24h	385		12,80	5,91	7,88	8,86
RICON® 140/40	18,00	97,00	C24	350	18,00	14,50	6,69	8,92	10,04
			GL24h	385		15,50	7,15	9,54	10,73
RICON® 160/40	18,00	117,00	C24	350		17,10	7,89	10,52	11,84
			GL24h	385		18,20	8,40	11,20	12,60

Service class : 1-2

 $\gamma_{M,\text{bois}} = 1,3$ Calculation of $F_{2,\text{Rd}}$ for timber-concrete connection:

$$F_{2,\text{Rk}} = \min \left\{ \begin{array}{l} \min F_{2,\text{Rd,timber}} \\ \min F_{2,\text{Rd,concrete}} \end{array} \right. \quad F_{2,\text{Rk,timber}} = \min \left\{ \begin{array}{l} \min F_{2,\text{KCC,Rk}} / \gamma_M \\ \min F_{2,\text{Rk}} \cdot k_{\text{mod}} \\ \gamma_{M,\text{timber}} \end{array} \right.$$

Note:

The fischer anchors for KNAPP wood-to-concrete connections were determined according to the above tables and on the basis of a concrete class C20/25 with the fischer C-FIX calculation tool. They have been specially checked by fischer. Any cases outside the tables must be checked by KNAPP®, fischer or a competent engineer. In many cases, dimensioning with the C-FIX calculation tool is sufficient. The complete analysis of concrete fasteners is available on request from KNAPP®. KNAPP® accepts no liability for the incorrect use of the tables in this document. The condition of the concrete elements (strength classes and surfaces) must be checked by a professional. KNAPP® accepts no responsibility for this. KNAPP® products and KNAPP® connectors must be installed in accordance with the respective installation rules and instructions as well as the respective Technical Assessments.

Other anchoring solutions are possible, they must be technically suitable and have an ETA technical assessment.

RICON® and RICON® inox

Post-beam connection for curtain walls (EA and DA)

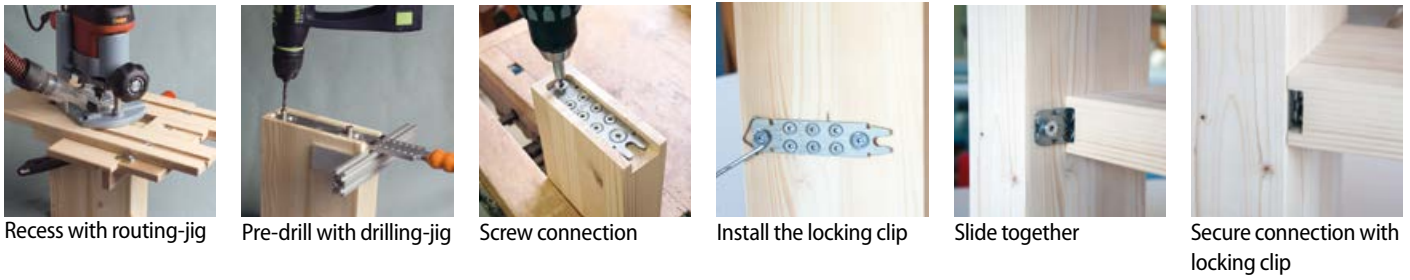

Locking clip

Depending on load requirements, the locking clip can be inserted on one or on both sides. If the connection is accessible, it can be unlocked.



To unlock the connection, it is necessary to bend up the locking clip in its center e.g. with a screwdriver.

Routing dimension RICON® inox		
Width	Height	Depth
40.5 mm	variable	11.5 ^{+0.5} mm
30.5 mm	variable	11.5 ^{+0.5} mm
20.0 mm	80 mm	11.0 ^{+0.5} mm
16.0 mm	66 mm	11.0 ^{+0.5} mm

Routing dimension RICON®		
Width	Height	Depth
40 mm	variable	12 mm

The recess can be routed on either side depending on the application. In this case (left picture), the connector plate is recessed into the beam/latch.

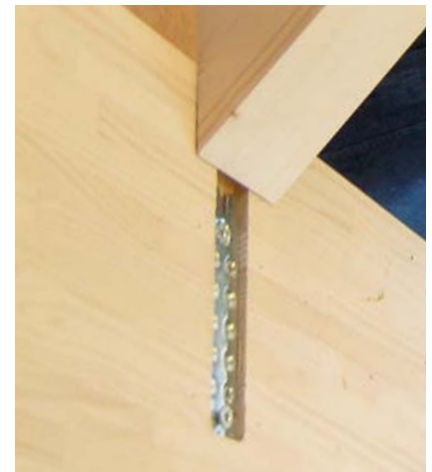

Rafter connection with RICON® 160/40.

RICON® wood to steel connection

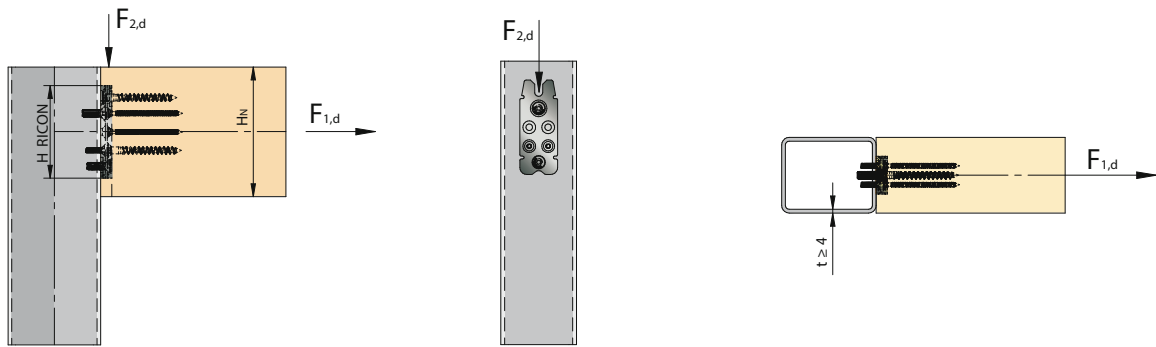

KNAPP® connector	Traction		Shear force	
	$F_{t,Rk}$ [kN]* on 4 mm steel	$F_{1,Rk}$ [kN]* on glulam GL24h	$F_{v,Rk}$ [kN]* on 4 mm steel	$F_{2,Rk}$ [kN]* on glulam GL24h
RICON 60x40	30,8	4,4	31,6	5,0
RICON 80x40				7,3
RICON 100x40				10,0
RICON 120x40				12,8
RICON 140x40				15,5
RICON 160x40				18,2
Sizing value calculation	$F_{t,Rd} = F_{t,Rk} / \gamma_{M,2}$	$F_{1,Rd} = k_{mod} \times F_{1,Rk} / \gamma_M$	$F_{v,Rd} = F_{v,Rk} / \gamma_{M,2}$	$F_{1,Rd} = k_{mod} \times F_{1,Rk} / \gamma_M$
	$\gamma_{M,2} = 1,25$	$\gamma_M = 1,3$	$\gamma_{M,2} = 1,25$	$\gamma_M = 1,3$
		$k_{mod} = 0,8$ KLED medium		$k_{mod} = 0,8$ KLED medium
		$k_{mod} = 0,9$ KLED short		$k_{mod} = 0,9$ KLED short
*Screw connection	2 CS M8x25	RICON® end-grain screw connection	2 CS M8x25	RICON® end-grain screw connection
	2 CS M5x20	CS 8x80, CS 5x80	2 CS M5x20	CS 8x80, CS 5x80

RICON® EA Startbox

RICON® boxes for post-beam and main-secondary beam connections up to 23.4 kN

Art.-No. K364/B



RICON®



TCT slotting
cutter 15x25 mm



Routing-jig
MULTI F



Drilling-jig



Depth gauge



Locking clip

Each RICON® Box includes:

6, 12 or 24 pairs of RICON®,
1 TCT slotting cutter,
1 routing-jig MULTI F 40/R,
1 drilling-jig,
1 depth gauge, CS-screws and
the locking clips

Application: curtain wall,
sunrooms, airport, etc.

RICON® EA Box | Art.-No. K364/B
6 pairs of 60/40 EA, 80/40 EA, 100/40 EA
and 120/40 EA, 24 locking clips and
RICON® CS-screws

AUSTRIA
ETA
ETA-10/0189
(2022/08/25)



RICON

RICON® EA Boxes

RICON® EA 60 Box

Art.-No. K366

24 pairs of RICON 60/40
48 CS-screws RICON® 5x50 mm
48 CS-screws RICON® 5x80 mm
24 CS-screws RICON® 8x50 mm
24 CS-screws RICON® 8x80 mm
24 locking clips



RICON® EA 80

Art.-No. K367

24 pairs of RICON® 80/40
48 CS-screws RICON® 5x50 mm
48 CS-screws RICON® 5x80 mm
48 CS-screws RICON® 8x50 mm
48 CS-screws RICON® 8x80 mm
24 locking clips



RICON® EA 100

Art.-No. K368

24 pairs of RICON® 100/40
96 CS-screws RICON® 5x50 mm
96 CS-screws RICON® 5x80 mm
48 CS-screws RICON® 8x50 mm
48 CS-screws RICON® 8x80 mm
24 locking clips



RICON® EA 120

Art.-No. K369

12 pairs of RICON® 120/40
72 CS-screws RICON® 5x50 mm
72 CS-screws RICON® 5x80 mm
24 CS-screws RICON® 8x50 mm
24 CS-screws RICON® 8x80 mm
12 locking clips



RICON® EA 140

Art.-No. K370

12 pairs of RICON® 140/40
96 CS-screws RICON® 5x50 mm
96 CS-screws RICON® 5x80 mm
24 CS-screws RICON® 8x50 mm
24 CS-screws RICON® 8x80 mm
12 locking clips



RICON® EA 160

Art.-No. K371

12 pairs of RICON® 160/40
120 CS-screws RICON® 5x50 mm
120 CS-screws RICON® 5x80 mm
24 CS-screws RICON® 8x50 mm
24 CS-screws RICON® 8x80 mm
12 locking clips



RICON® is also available in A2 inox up to 17.4 kN and in 13 sizes.

External woodwork

Fixing glazing and glazing beads with seal for external woodwork





FIXclip-Profile

Fixing and sealing systems for doors, glazing beads on wood and fixed or opening wood-aluminium joinery

As the first and only mounting system of its kind, the FIXclip-Profile makes it possible to combine the glazing and sealing process in one. Its innovative profile geometry saves time and reduces labor.

Benefits

The completely invisibly mounted FIXclip rail enables a perfect appearance due to flawless glazing beads. With this new glazing method, typical problems such as messy silicone joints or visible screw connections are a thing of the past.

GLE17, GLE17 plus, GLE18, GLE20 and GLE20 plus are a perfectly coordinated system for timber and timber/aluminium windows, regardless of whether glazing takes place in the factory or on site.

Application

Universally applicable for all common window and door systems, such as IV68/IV78 or fixed windows. As a stand-alone part, the FIXclip-Profile does not require a special outer sealing and can therefore be used in combination with a wet, dry or glued system method. The systems are used for flush and overlapped glazing beads.

Fastening

It will either be fixed with CS-Screws 3x20 (pre-drilled profile) or with a nailing gun and 16 gauge x 1" finish nails (1.2 x 25mm).

Alternatives

The FIXclip profile is available in the following designs: GLE17, GLE17 plus, GLE18, GLE20, GLE20 plus and GLE20 N. The standard colour is black. Other RAL colours are available on request at an extra charge for orders of 1,000 running meters or more.

GLE17

Art.-No. K311

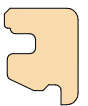
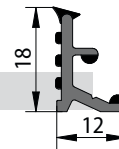

GLE17 Plus

Art.-No. K310

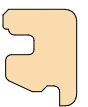
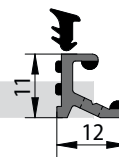

GLE18

Art.-No. K079

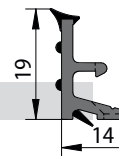

GLE20

Art.-No. K086

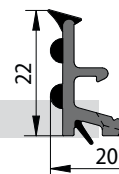

GLE20 Plus

Art.-No. K088/B

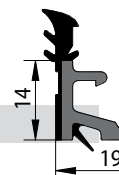

GLE20 N

Art.-No. K450



Conventionally fixed glazing bead with visible nails.



With FIXclip-Profile, no visible nails and tight joints.

FIXclip-Profile GLE17 / GLE17 Plus

Fixing and sealing systems for window construction



Art.-No. K311 + K310

GLE17

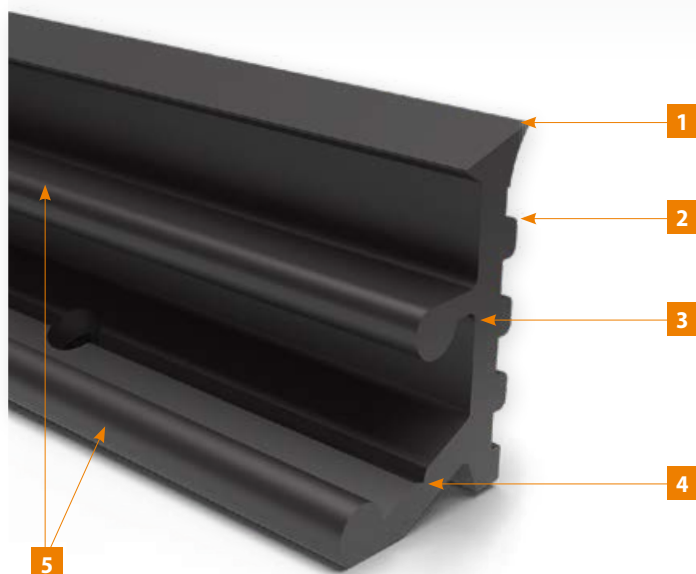

Benefits:

- | Glazing and sealing in one system
- | Saves labor – Effective production process guaranteed (also on site)
- | Perfect aesthetics - No visible fastening
- | Clean - Easy clipping on of the wooden glazing bead
- | Safe – No damage to the window glass by „faulty nailing“
- | Tested – Meets all of the highest standards of window manufacturing
- | Automatic sealing of the glass rebate

GLE17 Plus

Version Plus :

Separate wedge seal for easy and fast mounting directly on the construction site

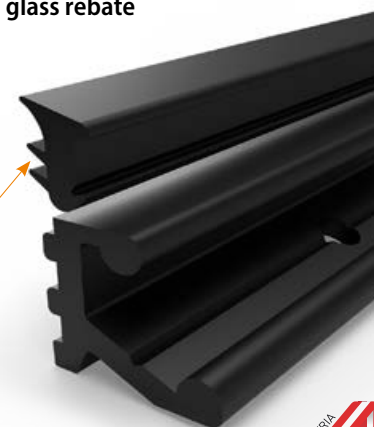

AUSTRIA

1 Soft sealing lip for optimal sealing of the window glass.

2 Soft contact surface for the protection and fixing of the window glass.

5 Soft rounded clamping ribs (for GLE17, GLE17 Plus and GLE20 N), or perfect fastening of the glazing bars, higher tolerance compensation, dismantling without damage.

3 Elastic, can be nailed, UV and weather resistant, resistant to varnishes, glazes and cleaning detergents.

4 Groove for nailing and prepunched holes for screws



PRODUCTS



VIDEO

Application: Wooden windows, wood-aluminum windows, wood-aluminum fixed glazing and doors

Choice of materials: Glazing beads made of wood and wood-based materials.

Installation: Milling the glazing bead by KNAPP® universal milling cutter, length cut, Fixing the profile and snap in glazing bead

Mounting: Using CS screws (3x20 mm) or 16 gauge x 1" finish nails (1.2 x 25 mm).

Dimensions : Profile length 6 metres. Pre-cutting possible on request.

Accessories: Universal milling head | Art.-No. K657, profile cutter | Art.-No. Z088 and assembly tool | Art.-No. Z085.

Installation

FIXclip-Profile



Cut to size glazing bead and FIXclip-profile

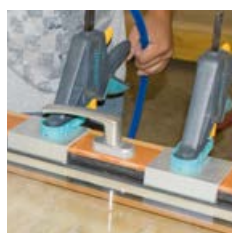

Pressing pane of glass against outer seal



Screw or nail the FIXclip-profile in place

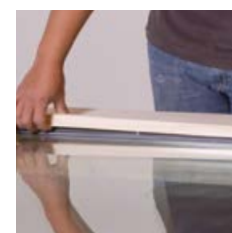

Clip on glazing bead.

FIXclip-Profile GLE17 and GLE17 Plus

Adjustments for machining with universal milling cutter FIXclip-Profile GLE17 + GLE17 plus

Milling cutter + profiling blades

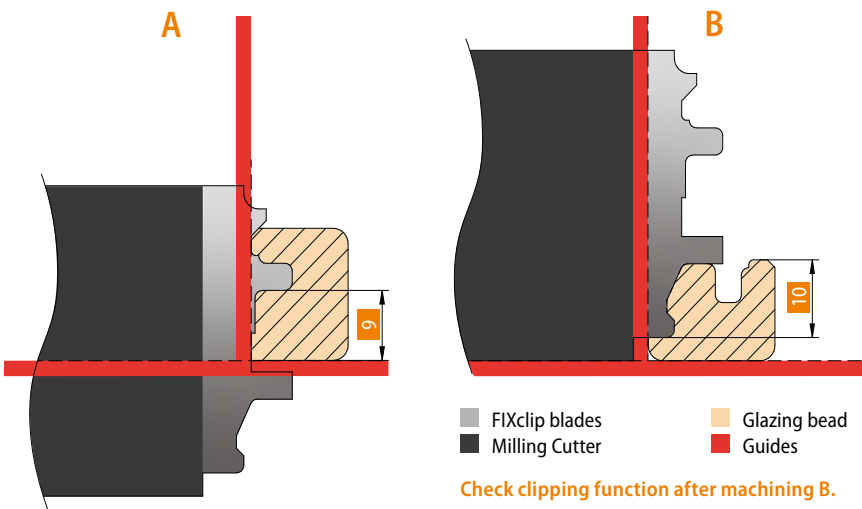

Milling Cutter GLE17

Art.-No. K657/SET

Milling cutter with profiling blades for FIXclip-Profile GLE17 and FIXclip-Profile GLE17 Plus (with Ø 30 mm bore)

FIXclip-Profile GLE17 dimensions

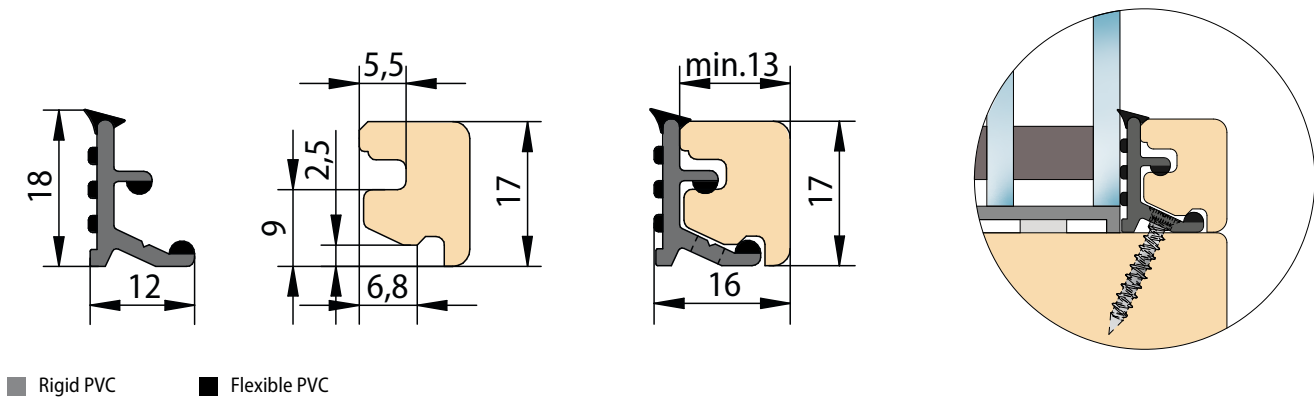

■ Rigid PVC ■ Flexible PVC

FIXclip-Profile GLE17 Plus dimensions

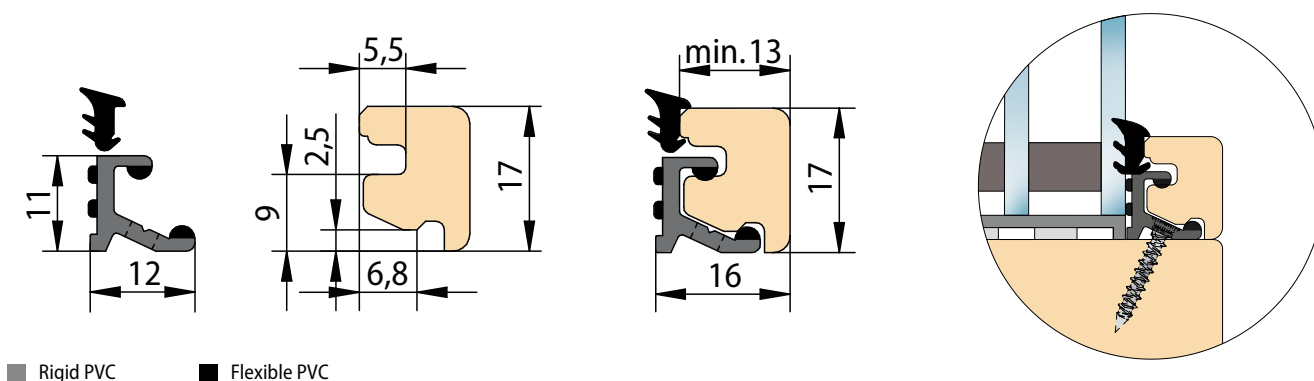

■ Rigid PVC ■ Flexible PVC

FIXclip-Profile GLE17 Plus and GLE20 Plus installation



Cut to size glazing bead and FIXclip-profile



Install FIXclip

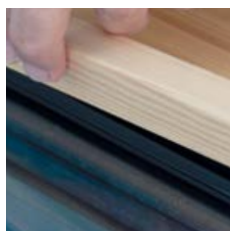

Clipping on the glass bead

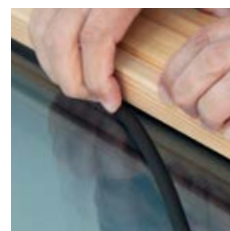

Press in wedge seal

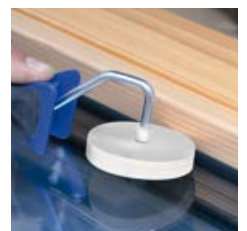

Easy handling with wedge roller

FIXclip-Profile GLE18

Adjustments for machining with universal milling cutter FIXclip-Profile GLE18

Milling cutter + profiling blades

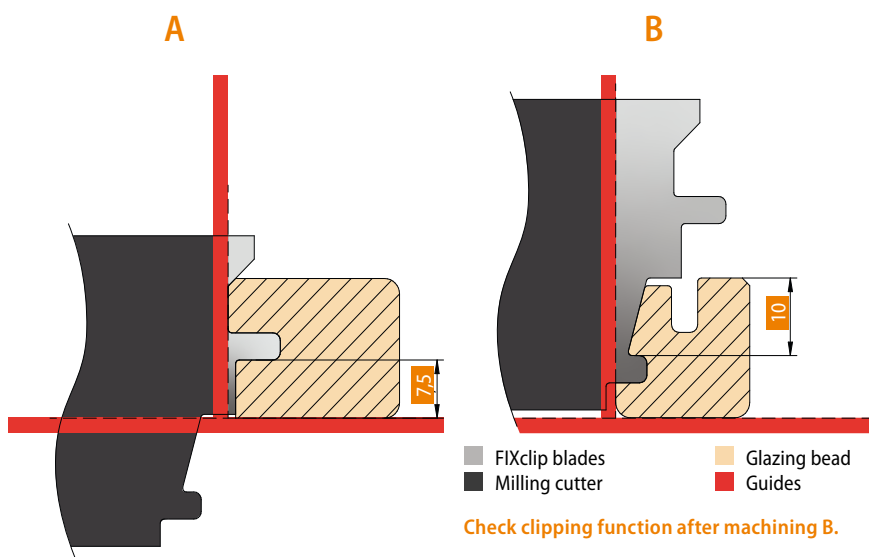

Milling Cutter GLE18

Art.-No. K655/SET

Milling cutter with profiling blades for FIXclip-Profile GLE18 (with \varnothing 30 mm bore)



PRODUCT

FIXclip-Profile GLE18 dimensions

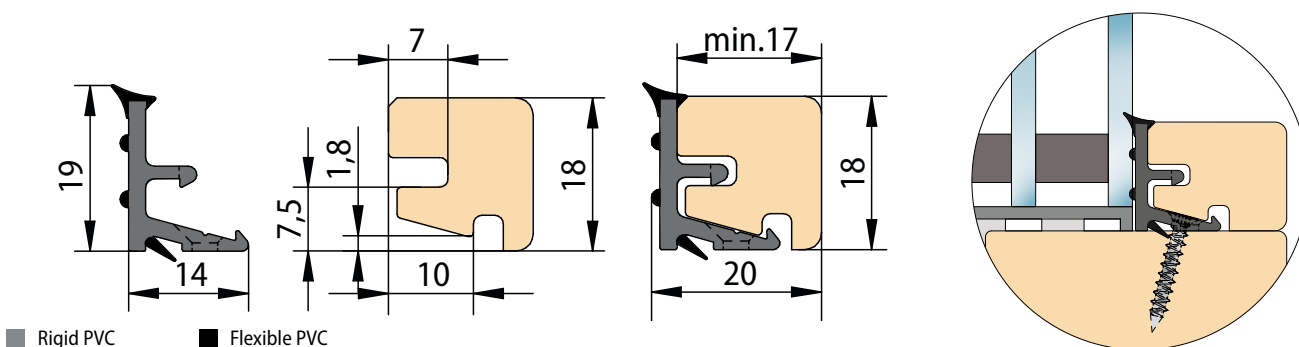

Processing options with FIXclip GLE18

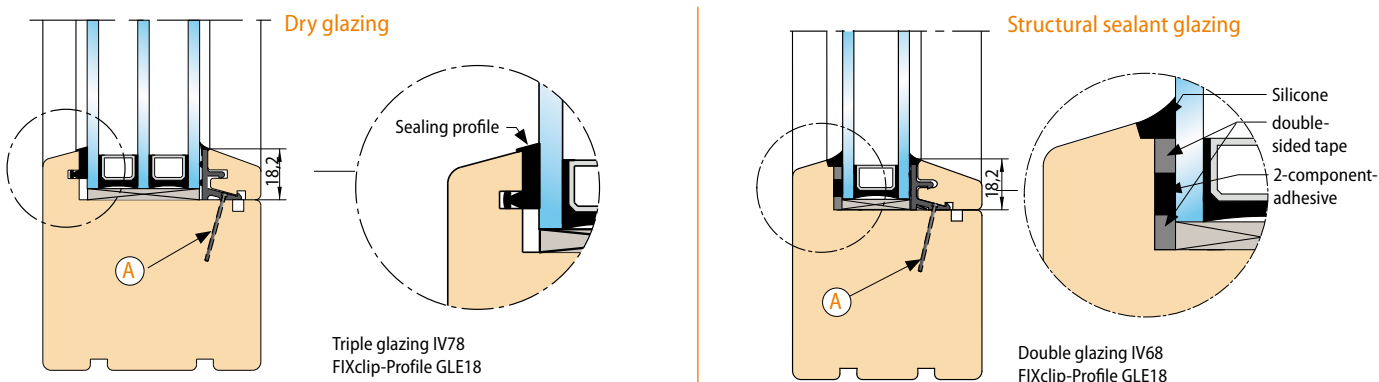

Installation of FIXclip-Profile GLE18 and GLE20 Plus



Cut to size glazing bead and FIXclip-profile



Screw in FIXclip-Profile

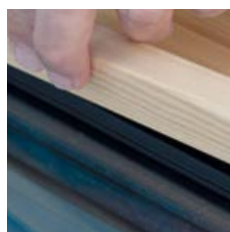

Clipping on the glass bead

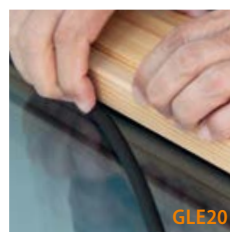

Press in wedge seal

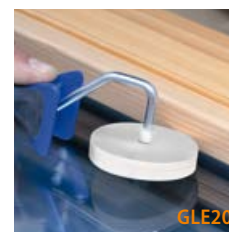

Easy handling with wedge roller

FIXclip-Profile GLE20, GLE20 Plus and GLE20 N

Adjustments for machining with universal milling cutter FIXclip-Profile

Milling cutter + profiling blades

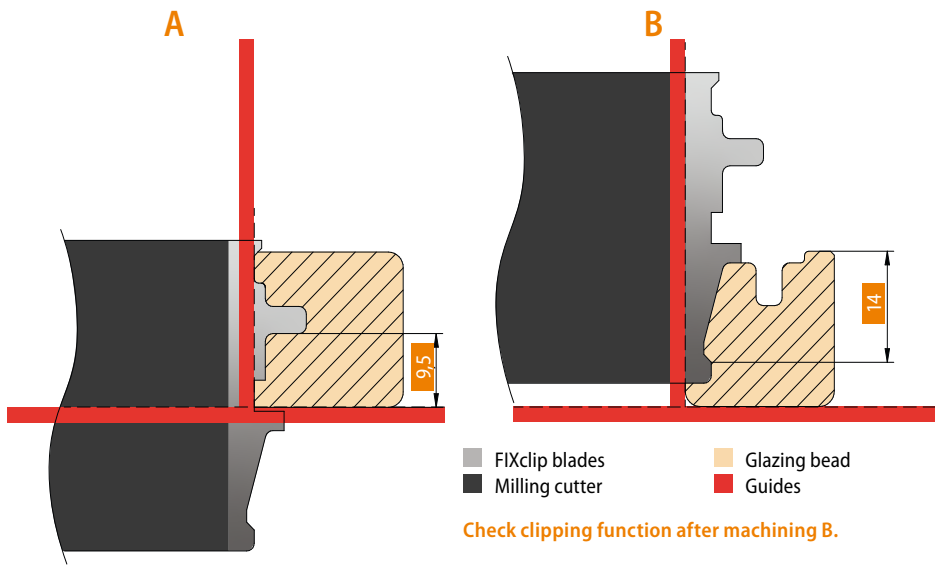

Milling Cutter GLE20

Art.-No. K659/SET

Milling cutter with profiling blades for FIXclip-Profile GLE20, FIXclip-Profile GLE20 Plus, and FIXclip-Profile GLE20 N (with Ø 30 mm bore)



FIXclip-Profile GLE20 dimensions

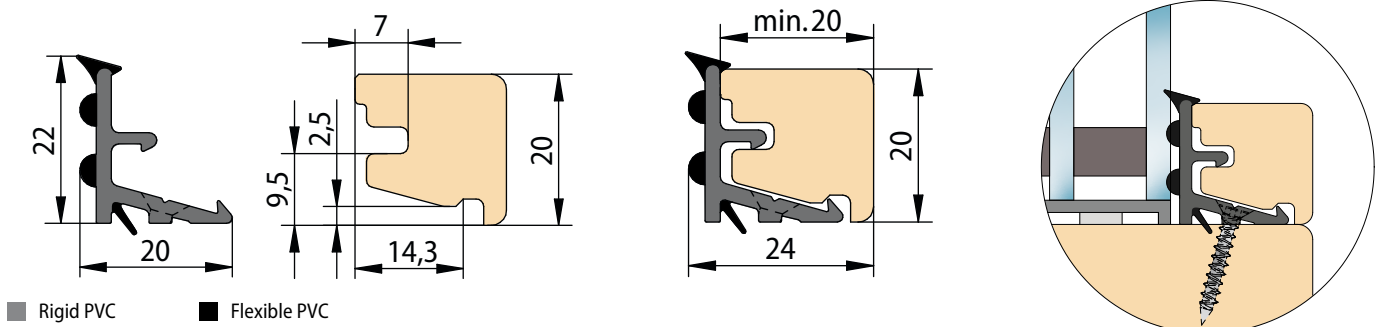

FIXclip-Profile GLE20 Plus dimensions

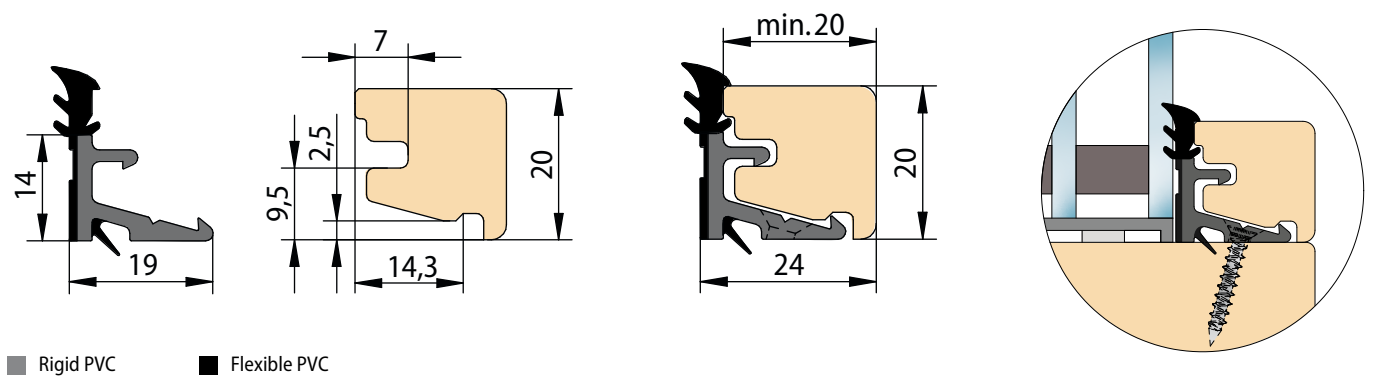

FIXclip-Profile GLE20 N dimensions

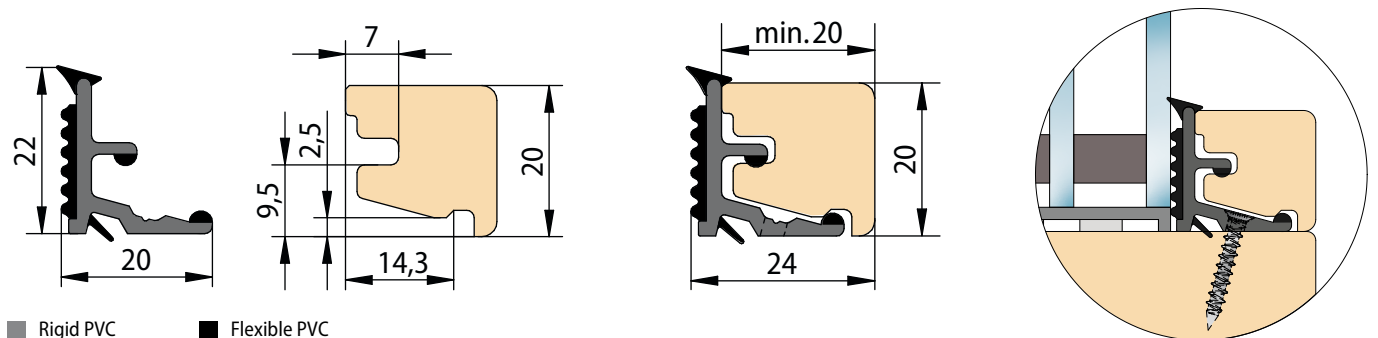

FIXclip-Profile accessories

Profiling blades FIXclip-Profile GLE17 and GLE17 Plus

Art.-No. K657

Application: machining of milling cutter for FIXclip-Profile GLE17 and GLE17 Plus.

Profiling blades FIXclip-Profile GLE18

Art.-No. K655

Application: machining of milling cutter for FIXclip-Profile GLE18.

Profiling blades FIXclip-Profile GLE20, GLE20 Plus and GLE20 N

Art.-No. K659

Application: machining of milling cutter for FIXclip-Profile GLE20, GLE20 Plus and GLE20 N.

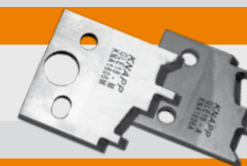

FIXclip-Profile wedge seal

Art.-No. Z096 Wedge seal FIXclip-Profile GLE17 Plus (Flexible PVC, black)

Wedge seal for easy installation and removal of glazing beads with FIXclip-Profile GLE17 Plus, even on site.

Wedge seal properties: high elasticity, heat resistant, UV and weather resistant, very good resilience, resistant to varnishes, stains and other common finishing products and cleaners.

Art.-No. Z091 Wedge seal FIXclip-Profile GLE20 Plus (Flexible PVC, black)

Art.-No. Z089 Wedge seal FIXclip-Profile GLE20 Plus (Flexible PVC, dark gray)

Wedge seal for easy installation and removal of glazing beads with FIXclip-Profile GLE20 Plus, even on site.

Properties: high elasticity, resistant to high temperatures, UV and weathering, very good elastic recovery of initial shape, resistant to varnishes, stains and other common finishing products and cleaners.

Available colours: black and dark grey. Other colours available on request. Delivered in rolls.

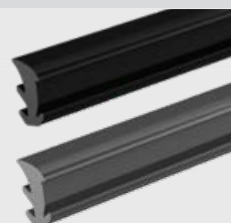

FIXclip-Profile tools

Art.-No. Z085 Mounting tool

Application: for pressing FIXclip-Profile with the Euro groove.

Art.-No. Z088 Slat cutter

Application: for fast and perfect cutting of FIXclip-Profile.

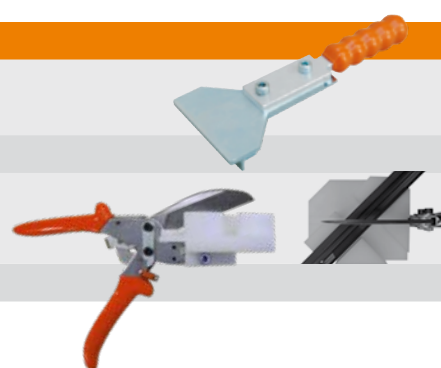

FIXclip-Profile screws

Art.-No. K502 CS-screws 3x20 mm

Alternative: finishing nails 1,2x25 mm.



FIXclip GLE20 plus

Fixing system for glazing and beading

Art.-No. K025 / K025 SET

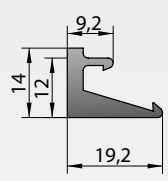

On request the FIXclip is also available in white.

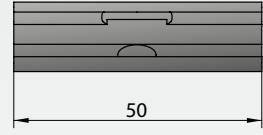

Increased contact pressure due to fastening with tilted screw

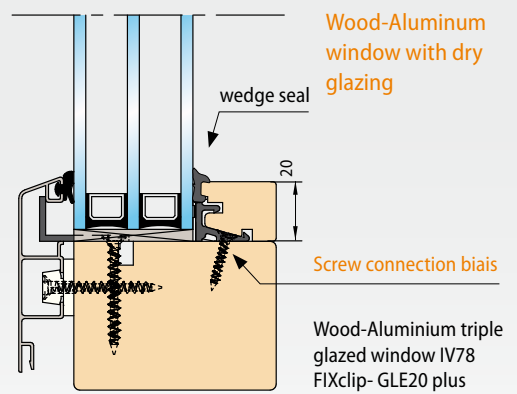

Benefits:

- Perfect for fixed glazing, an ideal solution for wedge sealing and also for wet glazing.
- Contact pressure is applied by means of a tilted screw connection
- Easy click-on of the glazing bead is guaranteed
- Easy removal of the glass pane after removal of the wedge seal
- Concealed installation of glazing beads, removable damage-free

The invisible fixing system for glazing bead FIXclip GLE20 Plus completes the FIXclip-Profile range. This is a simplified alternative to the to the profile bar.



Application:	Concealed fixing of wood and wood-aluminium window glazing beads, wood-aluminium fixed frames and doors.
Installation:	Machining the glazing beads on a router or machining centre with a special tool Art.-No. K656. Finished with glazing bead or silicone sealant.
Suitable materials:	Glazing beads and profiles in wood or plastic materials.
Mounting:	By screwing with KNAPP® SK inox screws 3.5x25 mm with drill point Art.-No. Z420.
Accessories:	FIXclip universal milling cutter Art.-No. K656, Wedge seal Art.-No. Z089.



Screw connection with KNAPP® 3.5x25 mm inox countersunk screw

Installation



Cut glazing bead to size

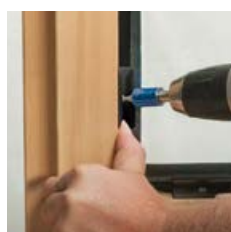

Screw in FIXclip GLE20 in a 45° angle



Clipping on the glass bead

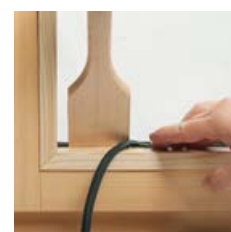

Press in wedge seal

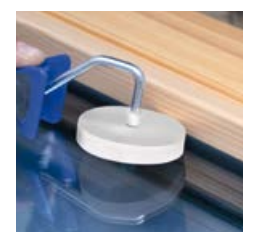

Easy handling with wedge roller

FIXclip

Moulding connectors for window construction (for fixing of glazing beads)



FIXclip H12

Art.-No. K078

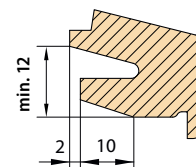
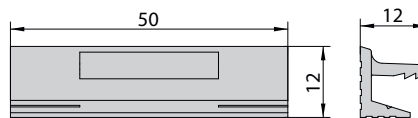

FIXclip H16

Art.-No. K076

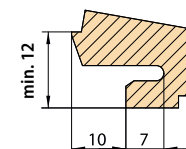
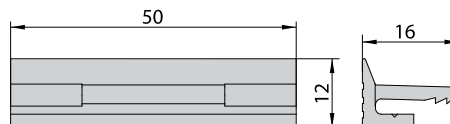

FIXclip H20

Art.-No. K077

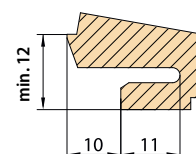
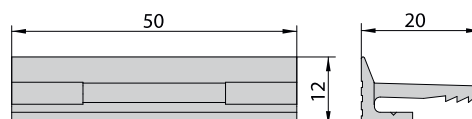

Benefits:

- Concealed installation of glass and profile moldings, can be disassembled without damage, tested for wind load C5 (EN 12210) and impact resistance class 3 (EN 13049).
- Perfect aesthetics - no visible fasteners
- Time-saving - effective production process guaranteed
- Fastening - by nailing or screwing
- For glazing bead frames and glazing beads, profiles made of wood or plastic materials

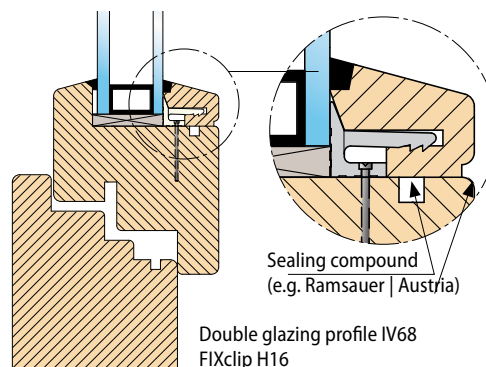

The glass and profile strip connectors have been tested by ift Rosenheim and HFA Vienna.

Proof of resistance to wind load, watertightness, air permeability and impact resistance

Proof resistance at wind load

Impact resistance proof

Test in accordance with ÖNORM EN 14351-1 and ÖNORM B5300 (partial tests of air permeability, watertightness, wind resistance)

ift windows product passport, according to EN 14351-1



- Resistance to wind load – EN 12210 – Class C5/B5
- Driving rain tightness – EN 12208 – Class E1050

- Air permeability – EN 12207 – Class 4
- Impact resistance – EN 13049 – Class 5



- FIXclip-Profile available in the system data base: www.ce-fix.de
- Easy and fast to the CE-mark and declaration of conformity
- Valid throughout Europe

Fixings for deck boards

Fasteners for cladding

Fixing for cladding wall panels

Outdoor assembly systems

Outdoor equipment

QUATRO 65, Z-DECK – Invisible fasteners for deck boards

Concealed fastening systems for terraces, cladding and wall cladding, indoors or outdoors



Kulmer Xenonlight (AT)

QUATRO 65

Art.-No. K080: Quatro 65/30

Art.-No. K081: Quatro 65/25

For decking boards and wall panels

Recommended for spacing no smaller than 7 mm



Quatro 65/25
Art.-No. K081

Quatro 65/30
Art.-No. K080

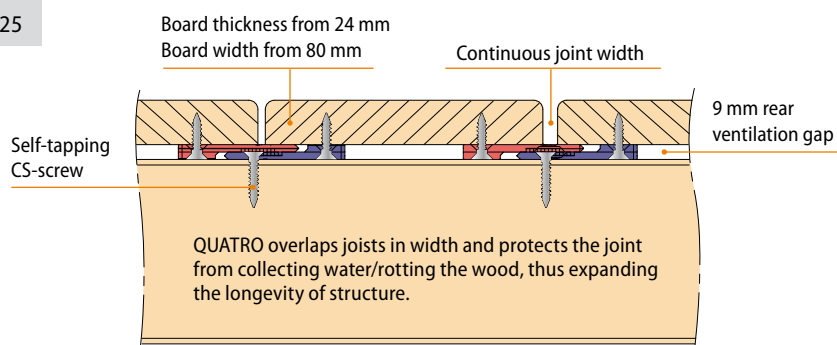

Self-tapping Stainless steel
CS-screw A2 5x25 mm for
board thicknesses 24-26 mm



Self-tapping Stainless steel
CS-screw A2 5x30 mm for
board thicknesses >26 mm

Approximate quantity per square meters

Board width	Pairs / m ²	Nb of m ² / package unit
150 mm	approx. 17 pairs	6 m ²
100 mm	approx. 25 pairs	4 m ²

(For a joist spacing of 500 mm)

- Concealed from the first to the last board
- Constructive wood protection of the substructure against rotting
- Rear ventilation due to distance between boards and joists
- Used also for wooden facades and formwork
- Easy installation with installation template
- Allows swelling and shrinkage of the boards
- UV and weather resistant plastic

Tips:

- Even the best connecting system cannot compensate for poor quality of wood. Make sure that the wood is dry and especially avoid boards from the core of the trunk and boards with a tendency to twist.
- Recommended length of boards: max. 3 m.
- Pre-drill, especially for hardwoods such as oak.
- Follow the installation recommendations of your quality wood supplier



QUATRO

QUATRO 65 installation

- Pre-drilling and continuous positioning of the joint spacing with the mounting template



Pre-drill with the
template



Fasten to the boards
with screws



Fasten to the joists
with screws



Use QUATRO 65 as
spacer



Mount the final board

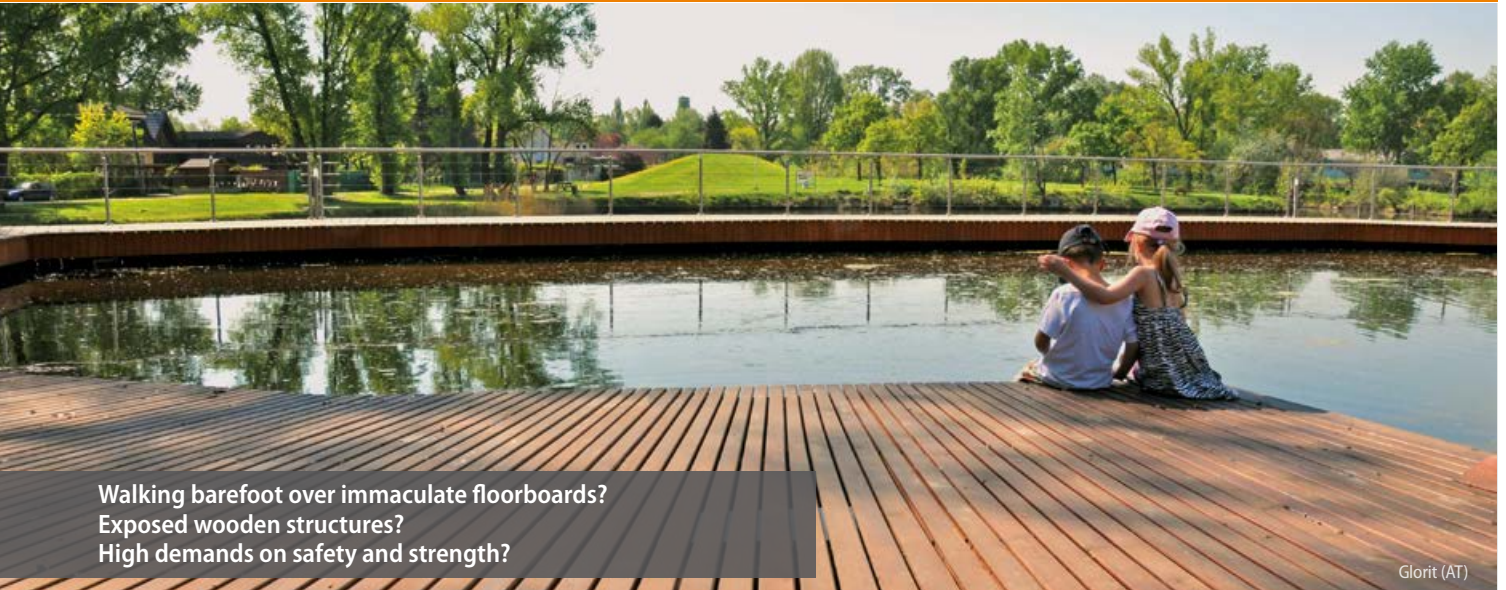

Glorit (AT)

Z-DECK

Art.-No. K082

For decking boards that are completely exposed to the weather

Recommended for rebated boards and gab of 7 mm or more



Self-tapping Stainless steel CS-screws A2 4,5x35 mm

- ▮ Robust - even suitable for beach and boat decks
- ▮ Boards can be replaced quickly and individually
- ▮ Optimum wood protection through self-cleaning joint design
- ▮ More stable than visible screwing from above
- ▮ Increased resistance against twisting of the boards
- ▮ Connectors and screws made of stainless steel



Z-DECK

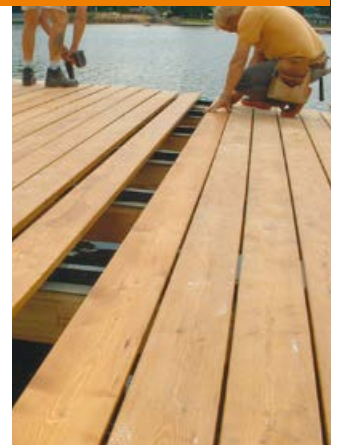

Approximate quantity per square meters

Board width	Pairs / m ²	Nb of m ² / package unit
150 mm	approx. 28 pairs	9 m ²
100 mm	approx. 40 pairs	6 m ²

(For a joist spacing of 500 mm)

Tips:

- ▮ Uneven the best connecting system cannot compensate poor quality of wood. Make sure that the wood is dry and especially avoid boards from the core of the trunk and boards with a tendency to twist.
- ▮ Pre-drill, especially for hardwoods such as oak..
- ▮ Follow the installation recommendations of your quality wood supplier.

Z-DECK installation

Create groove with rebate groove profile cutter

Art.-No. Z408



Routing with the router (optional)



Drive in



Screw in



Z-DECK is completely mounted



Pergola sunshade with UNO 30



Garden furniture with KNAPP® dowels



Fitting out your boat with KLIKK System and KNAPP® dowels.

Overview of Knapp solutions for outdoor use:

Concealed connecting system for outdoor- gardens, balconies, boat, and ship interior fittings.



Page 78

QUATRO 65

Made of highly resistant composite plastic

Quatro 65/25
Art.-No. K081

Quatro 65/30
Art.-No. K080



DECKING



Z-DECK

in inox
Art.-No. K082

Page 79



SLIPFIX

ZIPBOLT™ Exterior Slipfix

Handrail-post connection

Art.-No. Z374

Page 37



RICON® inox

Connectors for wooden structures, 13 sizes from 66/16, use in service class 3



RICON INOX

Page 48



UNO 30 (Set)

Hook connector in inox

Art.-No. K120
Set UNO 30

Art.-No. K120/B
UNO 30 (connector only)

Page 22



UNO 30



DUO 30 inox A5

hook connector in A5 stainless steel

Art.-No. K350

Art.-No. K350/P
Mini Pack

Art.-No. K121
A2 locking pin (option)



DUO30 INOX

Page 21



KNAPP®-DOWEL
selftightening plastic dowels

Art.-No. K066
6x28 mm

Art.-No. K067
8x36 mm

Art.-No. K169
8x50 mm

Page 24



DOWEL



Assortments and small volumes



Boxes & Mini Packs

KNAPP®-Boxes

For joiners, carpenters, window manufacturers, stair constructors and installer

Extensive range of boxes for carpenters, joiners, window / stair manufacturers and cabinetmakers

- ! A wide range of connectors including accessories
- ! Sets of assorted articles
- ! To all intents and purposes
- ! Custom-made in small quantities

DEKCLICK® Box – Clamp connectors

50 DEKCLICK blocs removable (black)
 50 DEKCLICK blocs extra grip (grey)
 50 DEKCLICK lamellar clamps removable (black)
 50 DEKCLICK lamellar clamps extra grip (grey)
 50 DEKCLICK screw clamps removable (black)
 100 CS-screws inox A2 5x50 mm,
 50 CS-screws inox 4x16 mm,
 25 Euro-screws 6,3x10 mm,
 300 CS-screws inox A2 4,5x35 mm,
 100 square nuts M6,
 1 Torx bit T15 with long shaft,
 1 Torx bit T25,
 1 DEKCLICK wood sample,
 1 KNAPP®-ADHESIVE PU+

Art.-No. K010/BOX

Application: for vertical and horizontal fastening of acoustic panels, decorative walls and ceiling coverings for indoor and outdoor use.



▶▶▶ online-store

www.knapp-connectors.com/en

miniKLiCK Box Dovetail connectors

400 miniKLiCK pairs,
 1 grooving saw blade
 Ø 120 mm with Ø 30 mm
 borehole for spindle moulder
 (more Ø on request)

Art.-No. K059/BOX

Application:
 Invisible assembly of
 small decorative parts,
 glazing beads on interior
 doors



KLiCK Box – Dovetail connectors

200 pcs. KLiCK,
 400 pcs. sKLiCK,
 400 PH-screws 3x13mm,
 100 pcs. KLiCKpro,
 1 Dovetail Router bit
 with Ø 8 mm shank

Art.-No. K045/BOX

Applications:
 Concealed fasteners
 for precisely fitting, and
 concealed interior design.



KOMBI-Box Hook connectors

100 pcs. G10 KOMBI hook connector,
 100 pcs. holding bracket, KOMBI G12/62, inox
 200 PH-screws 3x25 mm,
 200 CS-screws inox 4,5x35 mm,
 1 KNAPP®-ADHESIVE PU+

Art.-No. K616/BOX

Applications: Decorative claddings,
 exhibiton stands, shop
 and interior fitting.

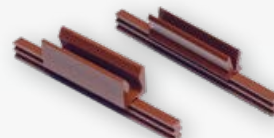

QUICK-SET Box 2-parts dowel connectors

125 pcs. QUICK Set 5 x 11 mm,
 125 pcs. QUICK Set 5 x 7,5 mm,
 125 pcs. QUICK Set 8 x 8 mm,
 125 pcs. QUICK Set 8 x 26 mm

Art.-No. Z056/BOX

Applications:
 Concealed, immediately
 functional without glue,
 2-parts cabinet connector.



DUO 30 Box 100 – Hook connectors

50 pairs of each:

DUO 30 mL and DUO 30 oL,
400 CS-screws 3,5x16 mm,
6 center punches,
2 handrail punches,
1 Forstner Bit Ø 30 mm,
with Ø 10 mm shank and
adjustable depth gauge,
1 drilling template

Art.-No. K070/BOX



DUO 30 Box 150 – Hook connectors

75 pairs of each:

DUO 30 mL and DUO 30 oL,
6 center punches, 2 handrail punches,
1 Forstner Bit (Ø 35 mm, Ø 10 mm shank
and adjustable depth gauge)

Recommended screws (not included):
CS-screws 3,5x16 mm (Art.-No. Z502)

Art.-No. K074/BOX



DUO 35 Box 100 – Hook connectors

50 pairs of each:

DUO 35 mL and DUO 35 oL,
400 Euro-screws 6,3x10 mm,
6 center punches DUO 35,
1 Forstner Bit (Ø 35 mm, Ø 10 mm shank
and adjustable depth gauge)

Art.-No. K061/BOX

Application: Concealed, self-locking,
removable, suitable to a CNC-routing
machine and to EURO screws.



**DUO 35 Box 150
Hook connectors**

75 pairs of each:

DUO 35 mL and DUO 35 oL,
6 center punches DUO 35

Recommended screws (not included):
EURO-screws 6,3x10 mm (Art.-No. Z510)

Art.-No. K062/BOX

Application:
Handrail, windows and doors,
facades, cladding, weatherboard,
decorative panels.



**UNO 30 Box 100
Hook connector**

100 UNO 30,
100 locking clips, inox,
100 CS-screws KNAPP® 5x50 mm
with washers TX25,
6 center punches UNO 30,
55 universal plastic dowels Ø 8 mm,
1 Forstner Bit (Ø 35 mm, Ø 10 mm shank
and adjustable depth gauge),
300 PH-screws KNAPP® A2 3x13 mm,
1 drilling template, 1 T25 Bit

Art.-No. K123/BOX
with KNAPP 5x50 mm galvanized screws

Art.-No. K123/EDEL
UNO 30 Box 100, inox



FIYU® Box

100 pairs FIYU® LOCK
100 pairs FIYU® FAST,
100 grub screws 6x12 mm,
100 tensioning screws 5x13 mm
1 Allen key with ball end

Art.-No. K856/BOX

Application: Furniture, cabinets, and
fittings connections



CONTRA 800 Box Connector for case goods

500 pcs. CONTRA 800,
250 EURO-(CS)-screws 6.3 x 10 mm,
250 EURO-(CS)-screws 6.3 x 30 mm,
250 CS-screws 4 x 16 mm,
250 CS-screws 4 x 40 mm,
1 Dovetail Router bit
with Ø 8 mm shank

Art.-No. K800/BOX

Application: All-purpose product for mounting crown and cover profiles, surface-mount fastener.

HITLINE Box 125 Biscuit connectors

125 pairs of SUNNY, SILVER and FAST, 1 Insert tool pour frapper les assembleurs

Art.-No. K053/BOX

Application: Heavy-duty fasteners (SILVER, FAST), concealed gluing helps (SUNNY).



MODULAR Box Cabinet connectors for 32 mm hole centers

125 pcs. each of MODULAR 4031 and 4032,
250 MODULAR 2055 shoulder screws, flat tip 13 mm,
56 MODULAR 2069 M4 shoulder screw M4 thread 15 mm,
56 MODULAR 2066 shoulder screw M4 bushing thread 16 mm,
1 Drill-and-test jig for groove.

Art.-No. Z4031/BOX

Application: Concealed junction of uprights - shelf, for wardrobe, bookcase, storage, cabinet unit.

CLASSIC Box Biscuit connectors

80 pairs each CHAMP and METAL,
50 pairs CLIPS,
160 PH-screws 3 x 13 mm,
160 PH-screws 3 x 25 mm,
2 CHAMP templates,
1 KNAPP®-ADHESIVE PU+

Art.-No. K301/BOX

Applications: Invisible and removable for mitres and corners, furniture, and interior design.

TREPPPO Box Levelling screws for stair treads

70 TREPPPO 40, 10 TREPPPO 70,
5 TREPPPO 100, 6 threaded pins,
3 KNAPP®-ADHESIVE PM+

Art.-No. Z320/BOX

Applications: Fixing wooden stair treads on concrete.



KNAPP®-DOWEL Box

500 KNAPP®-DOWEL 8 mm,
1000 KNAPP®-DOWEL 6 mm,
1 KNAPP®-ADHESIVE PU+

Art.-No. K066/BOX

Applications: Weatherproof plastic dowel for force-fit connection of wooden materials and windows.

Processing recommendation: Dowel Inserter Gannomat Selekt.



BOX



Mini Packs



DEKCLICK Pack

35 set | Art.-No. K010/PS
(removable, black)

Alternative:

35 set | Art.-No. K010/PG
(extra grip, grey),

including square nuts and CS-screws



DEKCLICK Pack

to screw in

35 set | Art.-No. K012/PS
(removable, black),

including square nuts and CS-screws



FAST Pack

90 pairs | Art.-No. K058/P

1 Insert tool



CLIPS Pack

44 pairs | Art.-No. K054/P

CLASSIC-SET Pack

24 pairs CHAMP, 24 pairs METAL, 8 pairs CLIPS
PH-screw 1 setting template | Art.-No. K301/P



HITLINE-SET Pack

25 pairs SUNNY, 25 pairs SILVER, 25 pairs FAST
1 Insert tool | Art.-No. K302/P



Where I can order small amounts of my connectors!

All 32 Minipacks are available in our online-store

- small volumes
- accessories included
- wide range of installation options



SUNNY Pack

110 pairs | Art.-No. K053/P

1 Insert tool



SILVER Pack

50 pairs | Art.-No. K049/P

1 Insert tool



CHAMP Pack

80 pairs | Art.-No. K023/P

1 template CHAMP



CHICO Pack

25 pairs | Art.-No. K030/P



METAL Pack

40 pairs | Art.-No. K026/P

PH-screws 3x13/3x25



DUO 30 inox A5 PACK

25 pairs | Art.-No. K350/P

2 center punches DUO 30



DUO 30 mL Pack

42 pairs | Art.-No. K070/P

2 center punches DUO 30



DUO 30 oL Pack

42 pairs | Art.-No. K074/P

2 center punches DUO 30



DUO 35 mL Pack

32 pairs | Art.-No. K061/P

2 center punches DUO 35



DUO 35 oL Pack

32 pairs | Art.-No. K062/P

2 center punches DUO 35



UNO 30 Pack

30 set | Art.-No. K120/P

25 set | Art.-No. K117/P

(with CS-screws A2 5x50)

CS-screws 5x50

PH-screws 3x13 mm A2 inox

Washers, inox A2

15 Locking clips

2 center punches UNO 30



KLICK Pack

250 pcs. | Art.-No. K045/P



KLICK + Fraise Pack

50 pcs. | Art.-No. K093/P

1 TCT-Router



sKLICK Pack

250 pcs. | Art.-No. K048/P

PH-screws 3x13



sKLICK + Fraise Pack

50 pcs. | Art.-No. K094/P

PH-screws 3x13

1 TCT-Router



sKLICK + KLICKpro Pack

125 pcs. | Art.-No. K092/P

PH-screws 3x13



DUO 46/15 Pack

18 pairs | Art.-No. K041/P

CS-screws 5x40/5x60

PH-screws 5x40/5x60



DUO 62/15 Pack

16 pairs | Art.-No. K036/P

CS-screws 5x40/5x60

PH-screws 5x40/5x60



DUO 62/30 Pack

8 pairs | Art.-No. K022/P

CS-screws 5x40/5x60

PH-screws 5x40/5x60



DUO 100/15 Pack

12 pairs | Art.-No. K055/P

CS-screws 5x40/5x60

PH-screws 5x40/5x60



DUO 46/30 Pack

10 pairs | Art.-No. K046/P

CS-screws 5x40/5x60

PH-screws 5x40/5x60

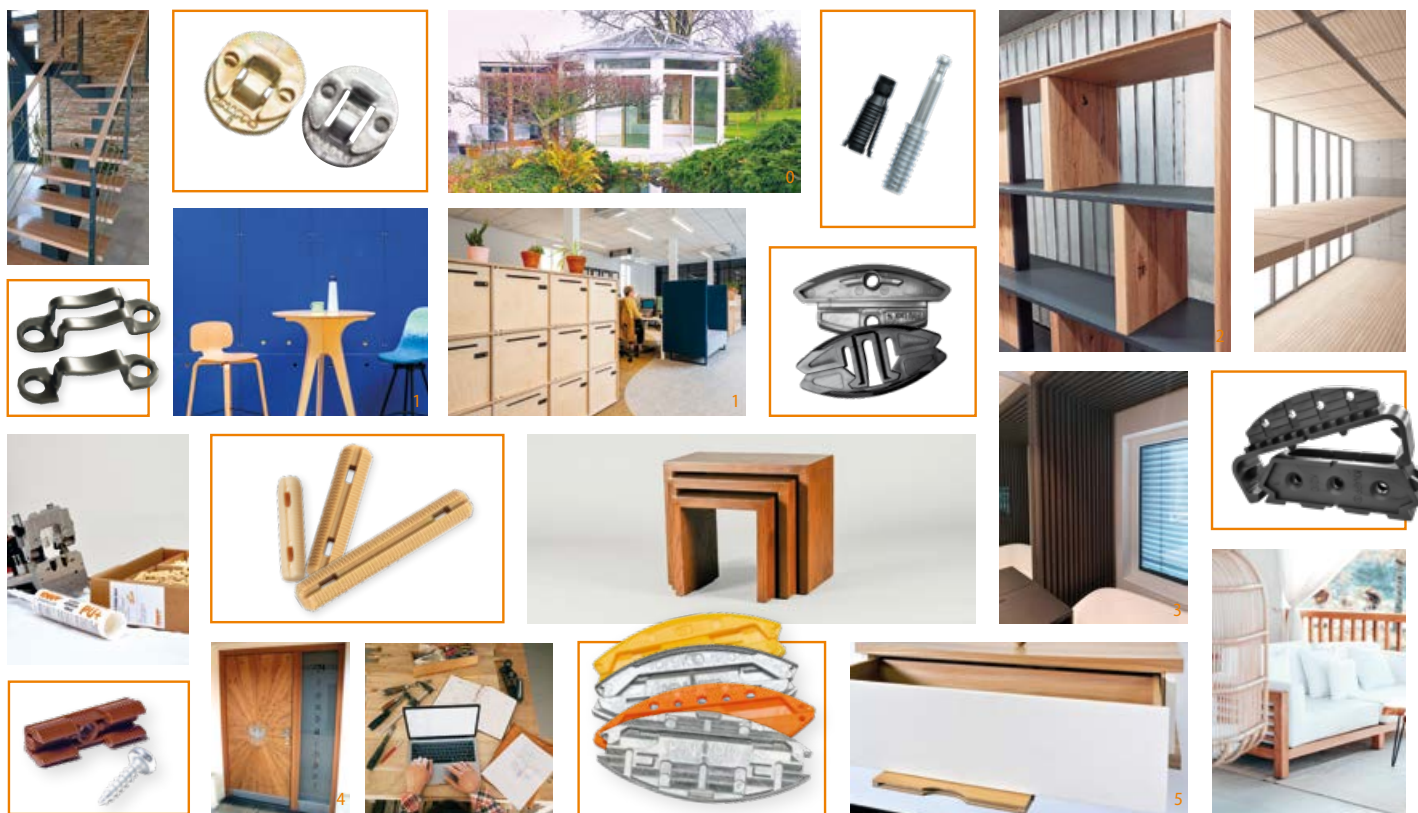

Connecting

Your ideas

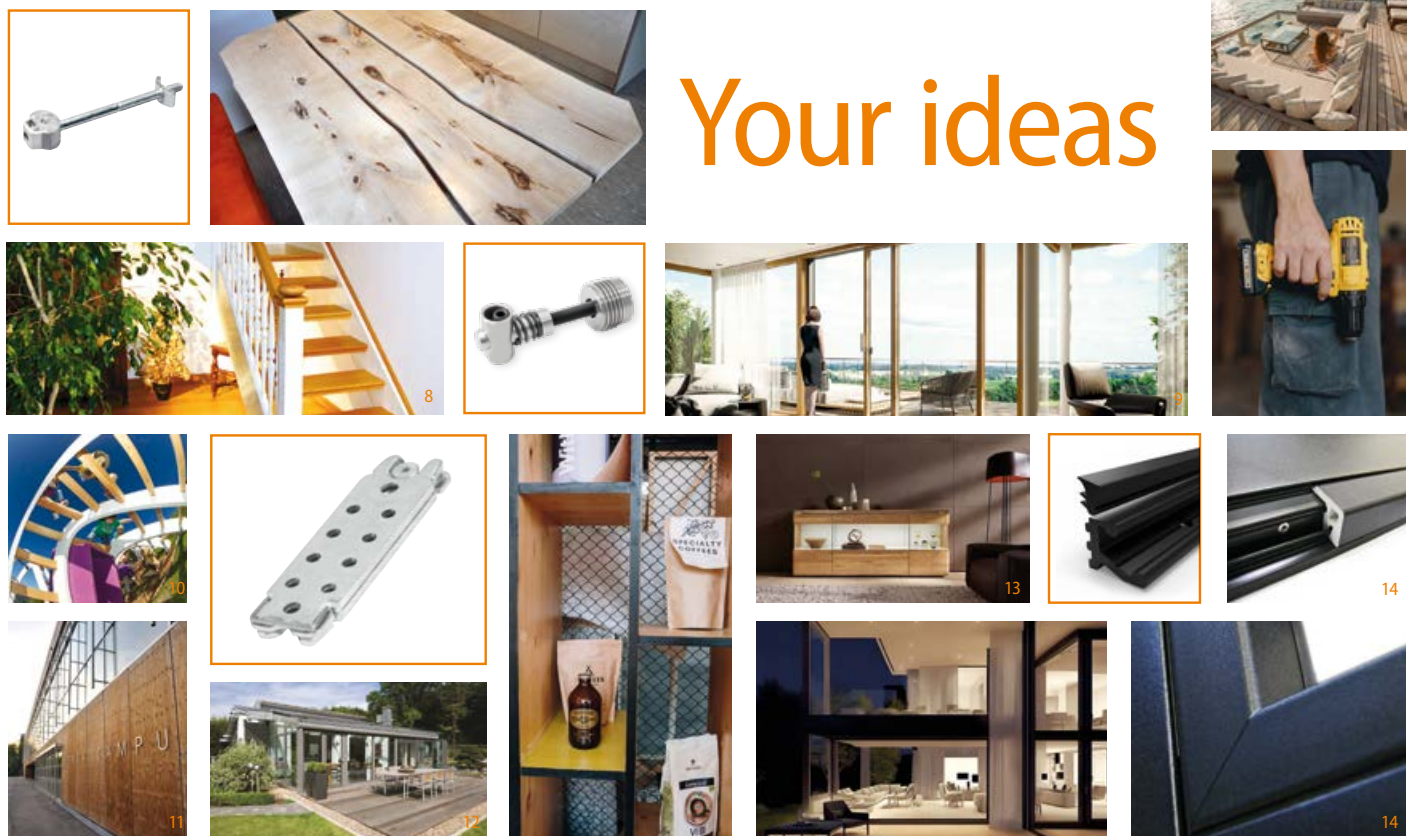

Innovative solutions
 Made in Austria
 Family Business
 since 1983
 Your partner for,
 interior design



▶▶▶ On-site consultation

For international requests, we are also available via video call or through our business partners. All contact details are available on our website:

www.knapp-connectors.com/en/contacts/



▶▶▶ Contact

 +43 (0) 7474 / 799 10

 +43 (0) 7474 / 799 10 28

info@knapp-connectors.com



▶▶▶ Downloads

All brochures, assembly instructions, CAD drawings and many details can be downloaded after registration on our website.

knapp-connectors.com/en/downloads

**HOW TO ORDER?
 AS SIMPLE AS THAT:**

Scan the QR code with your mobile phone or visit our website www.knapp-connectors.com/en/ register on your first visit or log in with your login details and access our online shop directly...



▶▶▶ online-store

Not available in Switzerland and in the Americas



Concealed | Self-tightening | Demountable



patented by
KNAPP®

20.02.2024 | Connecting systems for interior and exterior design, carpentry and wood working brochure | © The KNAPP logo is a registered trademark of the trademark owner Knapp GmbH, A-3324 Euratsfeld.

The technical content of this brochure is valid until a new version is published (always updated and downloadable from the internet). This document is the exclusive property of Knapp GmbH. Any copying, reproduction, publication and also the use of extracts are subject to the prior written consent of Knapp GmbH. Errors, misprints or changes excepted and technical reservations. The verification and adaptation of drawings, calculations or any technical details, in particular static data, remain the responsibility of the customer. Additional calculations and drawings published by Knapp GmbH are suggestions for orientation and are not guarantees, the customers are always obliged to check these data and to adapt them to their specific case. The pictures in this document are available in computer format on request from our marketing department. All rights reserved. Copyright © 2023-24 by Knapp GmbH.



Knapp GmbH | Wassergasse 31 | A-3324 Euratsfeld
Tél. : +43 (0)7474 / 799 10 | Fax: +43 (0)7474 / 799 10 99
E-Mail : info@knapp-connectors.com | www.knapp-connectors.com/en



 [online-store](#)

KNAPP®
connectors.com